

2MP 16X LightHunter Network PTZ Dome Camera Datasheet

IPC6432LR-X16-VG1



Features

- High quality image with 2MP, 1/2.8" CMOS sensor
- 1920*1080@60fps in the main stream
- Ultra 265, H.265, H.264, MJPEG
- Dual streams
- 16X optical zoom
- LightHunter technology ensures ultra-high image quality in low illumination environment
- Smart IR, up to 100m (328ft) IR distance
- DC12V \pm 10% or PoE+ (IEEE 802.3at)
- Alarm 2 in and 1 out, audio 1 in and 1 out
- IP66 ingress protection
- IK10 vandal resistant

Specifications

Camera	Description
Resolution	2MP
Sensor	1/2.8"CMOS
Min. Illumination	Colour: 0.003 Lux (F1.78, AGC ON) 0 Lux with IR
Day/Night	IR-cut filter with auto switch (ICR)
Shutter	Auto/Manual, 1 ~ 1/100000s
WDR	120dB
S/N	>52dB
Lens	Description
Lens type	5.5~88mm
Optical Zoom	16X
Iris	F1.78-F3.73
Field of View (H)	52.46° ~3.67°
Field of View (V)	30.98° ~2.07°
Field of View (D)	64.53° ~4.33°
DORI	Description
DORI Distance (Detect)	88.0m~1412.7m(288.7ft~4634.8ft)
DORI Distance (Observe)	35.2m~565.1m(115.5ft~1853.9ft)
DORI Distance (Recognize)	17.6m~282.5m(57.7ft~927.0ft)
DORI Distance (Identify)	8.8m~141.3m(28.9ft~463.5ft)
Illuminator	Description
Illumination Distance(IR)	Up to 100m (328 ft) IR range
Wavelength	850nm
IR On/Off Control	Auto/Manual
Video	Description
Video Compression	Ultra 265; H.265; H.264; MJPEG
Video stream	Dual streams
Frame Rate	Main Stream: 2MP(1920*1080),Max 60fps Sub Stream: 720P(1280*720), Max 60fps
Video Bit Rate	128 Kbps~16 Mbps
U-code	Support
ROI	Support
OSD	Up to 4 OSDs
Privacy Mask	24 areas, up to 4 areas per scene
Image	Description
White Balance	Auto; Outdoor; Fine Tune; Sodium Lamp; Locked; Auto2
Digital noise reduction	2D/3D DNR

Smart IR	Support
Flip	Normal; Flip Vertical; Flip Horizontal; 180°
HLC	Support
BLC	Support
Defog	Digital Defog
Intelligent	Description
Smart intrusion prevention	Support false alarm filtering: Cross line detection, Intrusion detection
Auto-Tracking	Support, target filtering: vehicle, humanbody
Events	Description
Basic Detection	Motion detection; Tampering alarm; Audio detection
General Function	Watermark; IP Address Filtering; Access Policy; ARP Protection; RTSP Authentication; User Authentication; Alarm input
Audio	Description
Audio Compression	G.711U; G.711A
Audio Bitrate	128 Kbps
Two-way Audio	Support
Suppression	Support
Sampling Rate	16KHZ
Storage	Description
Edge Storage	Micro SD, up to 256 GB
Network Storage	ANR; NAS(NFS)
Network	Description
Protocols	IPv4; IPv6; IGMP; RTP; ICMP; ARP; TCP; UDP; DHCP; PPPoE; RTSP; RTCP; RTMP; DNS; DDNS; NTP; FTP; UPnP; HTTP; HTTPS; 802.1x; SNMP; QoS; SSL/TLS
Compatible Integration	ONVIF (Profile S, Profile G, Profile T); API; SDK
User/Host	Up to 32 users. 3 user levels: administrator, common user and operator
Security	Password protection; Strong password; HTTPS encryption; Export operation logs; Basic and digest authentication for RTSP; Digest authentication for HTTP; TLS 1.2; WSSE and digest authentication for ONVIF
Client	EZStation; EZLive; EZView
Web Browser	Plug-in required live view: IE 10 and above, Chrome 45 and above, Firefox 52 and above, Edge 79 and above
Pan/Tilt	Description
Pan Range	360° (endless)
Pan Speed	0.1° /s~240° /s
Tilt Range	- 5° ~90° (auto flip)
Tilt Speed	0.1° /s~120° /s
Number of Presets	1024
Preset Patrol	16 patrols, up to 64 presets for each patrol
Route Patrol	16 patrols, up to 32 actions for each patrol
Recorded Patrol	16 patrols, up to 128 actions for each patrol

Patrol Stay Time	15s~1800s
Home Position	Support
Interface	Description
Audio I/O	1/1
Alarm I/O	2/1
Serial Port	1*RS485
Network	1*RJ45 10M/100M Base-TX Ethernet
Certification	Description
EMC	CE-EMC (EN 55032: 2015+A11:2020+A1: 2020,EN IEC 61000-3-2: 2019+A1: 2021,EN 61000-3-3: 2013+A1: 2019+A2:2021,EN 50130-4: 2011+A1:2014) FCC (FCC CFR 47 part15 B, ANSI C63.4-2014)
Safety	CE LVD (EN 62368-1:2014+A11:2017) UL (UL 62368-1, 2nd Ed., Issue Date: 2014-12-01)
Environment	CE-RoHS (2011/65/EU;(EU)2015/863)
Protection	IP66 (IEC 60529:1989+AMD1:1999+AMD2:2013) IK10 (IEC 62262:2002)
General	Description
Power	DC12V($\pm 10\%$,3A), PoE+(IEEE 802.3at)
Power Consumption	Max 23W
Power Interface	\varnothing 5.5mm coaxial power plug
Dimensions	\varnothing 167 x 181mm(\varnothing 6.6" x 7.1")
Weight	2.3Kg(5.07lb)
Working Environment	-40°C~65°C (-40° F~149° F), Humidity: $\leq 95\%$ RH (non-condensing)
Storage Environment	-40°C~70°C (-40° F~158° F), Humidity: $\leq 95\%$ RH (non-condensing)
Surge protection	6KV
Reset button	Support

Dimensions

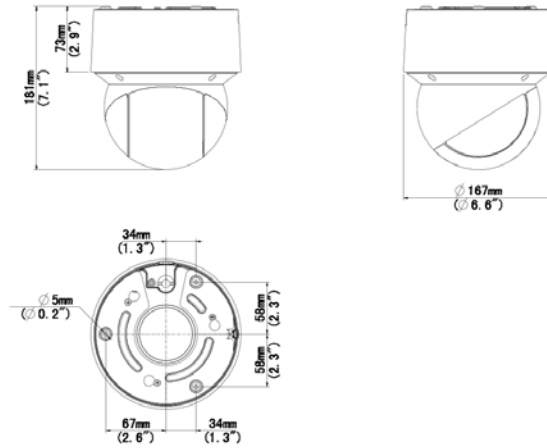

Zhejiang Uniview Technologies Co., Ltd.

No. 369, Xietong Road, Xixing Sub-district, Binjiang District, Hangzhou City, 310051, Zhejiang Province, China

Email: overseasbusiness@uniview.com; globalsupport@uniview.com

<http://www.uniview.com>

©2023-2024 Zhejiang Uniview Technologies Co., Ltd. All rights reserved.

*Product specifications and availability are subject to change without notice.

*Despite our best efforts, technical or typographical errors may exist in this document. Uniview cannot be held responsible for any such errors and reserves the right to change the contents of this document without prior notice.