

# 16MP LightHunter 180° OmniView Network Camera

IPC8544EA-KM-I1

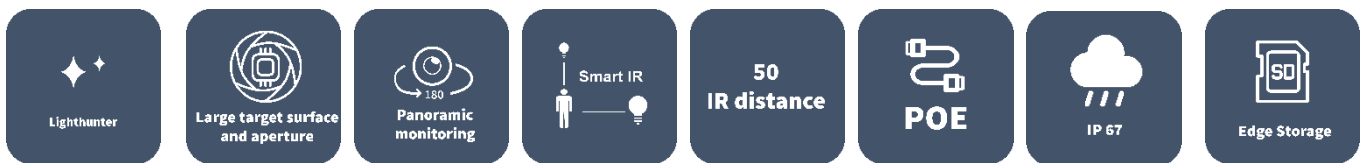

## Key Features



- High quality image with 16MP, 1/1.8" CMOS sensor
- 4800\*2688@30fps in the main stream offers 180° panoramic view, and 16:9 ratio can better fit the screen
- Smart IR, up to 50m (164 ft) IR distance
- Built-in fan, allows dissipating heat and eliminating the mist of window
- Ultra 265,H.265, H.264, MJPEG
- 2D/3D DNR (Digital Noise Reduction)
- AC24V, DC24V or PoE(IEEE 802.3at) power supply
- Micro SD, up to 256 GB
- Alarm 2 in and 1 out, Audio 1 in and 1 out
- IP67 ingress protection

## Specifications

IPC8544EA-KM-I1					
<b>Camera</b>					
Sensor	1/1.8" progressive scan, 4.0 megapixel, CMOS				
Min. Illumination	Colour: 0.001lux (F1.6,AGC ON) 0lux with IR				
Day/Night	IR-cut filter with auto switch (ICR)				
Shutter	Auto/Manual, shutter time: 1 s ~ 1/100000 s				
WDR	Digital WDR				
S/N	>56dB				
<b>Lens</b>					
Lens	4×2.8mm lens				
Iris	F1.6				
Field of View (H)	180°				
Field of View (V)	90°				
Field of View (D)	221.4°				
<b>DORI</b>					
DORI Distance	Lens (mm)	Detect (m)	Observe (m)	Recognize (m)	Identify (m)
	2.8	63.0(206.7ft)	25.2(82.7ft)	12.6(41.3ft)	6.3(20.7ft)
<b>Illuminator</b>					
IR Range	Up to 50m (164ft) IR range				
Wavelength	850nm				
IR On/Off Control	Auto/Manual				
<b>Video</b>					
Video Compression	Ultra 265, H.265, H.264, MJPEG				
Frame Rate	Main Stream: 4800×2688:Max. 30 fps; Sub Stream: 2688×1520:Max. 30 fps; Third Stream: 1280×720: Max. 30 fps;				
Video Bit Rate	128 Kbps~16 Mbps				
ROI	Up to 8 areas				
Video stream	Triple streams				
OSD	Up to 8 OSDs				
Privacy Mask	Up to 8 areas(8 blacks/8 mosaics)				
<b>Image</b>					
White Balance	Auto/Outdoor/Fine Tune/Sodium Lamp/Locked/Auto2				
Digital noise reduction	2D/3D DNR				
Smart IR	Support				
Flip	Normal/Flip Vertical/Flip Horizontal/180°				
HLC	Support				
BLC	Support				
Defog	Digital Defog				
<b>Events</b>					
General Function	Watermark, IP Address Filtering, Tampering Alarm, Alarm input, Alarm output, Access Policy, ARP Protection, RTSP Authentication, User Authentication				
<b>Audio</b>					
Audio Compression	G.711U, G.711A				

Two-way Audio	Supported
Suppression	Supported
Sampling Rate	8KHz
<b>Storage</b>	
Edge Storage	Micro SD, up to 256 GB
Network Storage	ANR,NAS(NFS)
<b>Network</b>	
Protocols	IPv4, IGMP, ICMP, ARP, TCP, UDP, DHCP, PPPoE, RTP, RTSP, RTCP, DNS, DDNS, NTP, FTP, UPnP, HTTP, HTTPS, SMTP, 802.1x, SNMP, QoS, RTMP
Compatible Integration	ONVIF (Profile S, Profile G, Profile T), API
Client	EZStation EZLive EZView
Web Browser	Plug-in required live view: IE9+, Chrome 41 and below, Firefox 52 and below
<b>Interface</b>	
Audio I/O	Audio cable
	1 Input: impedance 35kΩ; amplitude 2V [p-p]
	1 output: impedance 600Ω; amplitude 2V [p-p]
Alarm I/O	2/1
Network	10M/100M/1000M Base-TX Ethernet
<b>Certification</b>	
EMC	CE-EMC (EN 55032: 2015+A1:2020,EN 61000-3-3: 2013+A1: 2019,EN IEC 61000-3-2: 2019+A1: 2021,EN 55035: 2017+A11:2020) FCC (FCC CFR 47 part15 B, ANSI C63.4-2014)
Safety	CE LVD (EN 62368-1:2014+A11:2017) CB (IEC 62368-1:2014) UL (UL 62368-1, 2nd Ed., Issue Date: 2014-12-01)
Environment	CE-RoHS (2011/65/EU;(EU)2015/863); WEEE (2012/19/EU); Reach (Regulation (EC) No 1907/2006)
Protection	IP67 (IEC 60529:1989+AMD1:1999+AMD2:2013)
<b>General</b>	
Power	AC24V±25%/DC24V±25%, PoE(IEEE 802.3at)
	Power consumption: Max 34W
Dimensions (∅ x H)	258.8mmx211.0mmx115.0mm(10.2"x8.3"x4.5")
Weight	2.271kg(5.01lb)
Working Environment	-40°C ~ +70°C (-40°F ~ 158°F), Humidity: ≤95%RH RH(non-condensing)
Storage Environment	-40°C ~ +70°C (-40°F ~ 158°F), Humidity: ≤95%RH RH(non-condensing)
surge protection	6KV

## Dimensions

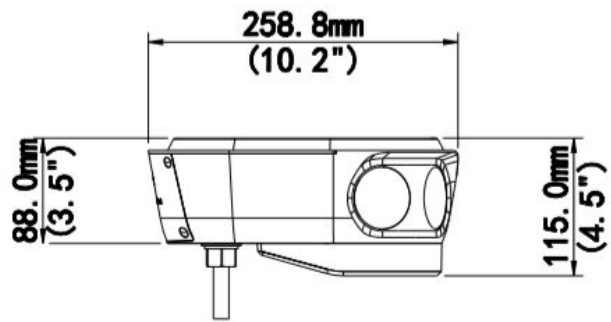
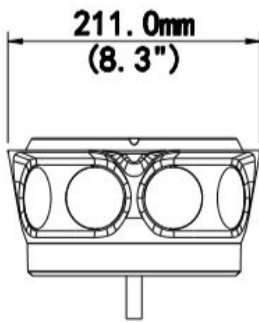
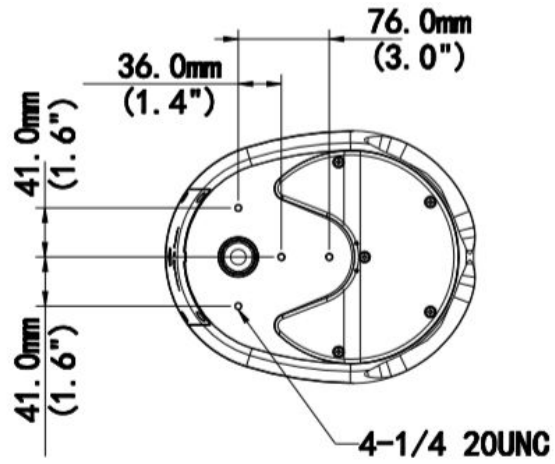

## Accessories

TR-WE45-D-IN  
Wall Mount



TR-JB07-D-IN  
Junction Box

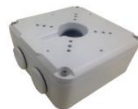

TR-CM06-C-IN  
Pendant mount



TR-UV06-C-IN  
2D Bracket Mount



TR-UP06-IN  
Pole Mount



TR-UP06-B-IN  
Pole Mount

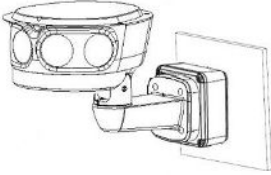
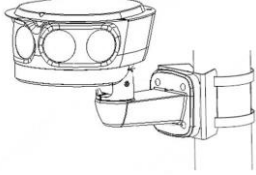
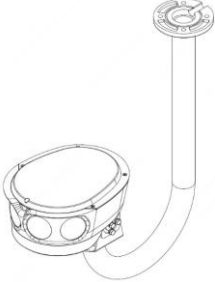
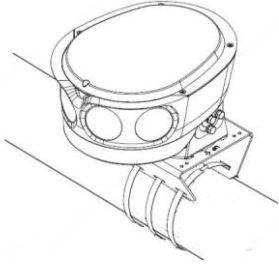

Junction Mount	Pole Mount
TR-WE45-D-IN + TR-JB07-D-IN	TR-WE45-D-IN + TR-UP06-B-IN
	
Pendent Mount	Horizontal Pole Mount
TR-CM06-C-IN	TR-UV06-C-IN+ TR-UP06-IN
	

**Zhejiang Uniview Technologies Co., Ltd.**

Building No.10, Wanlun Science Park, Jiangling Road 88, Binjiang District, Hangzhou, Zhejiang, China (310051)

Email: [overseasbusiness@uniview.com](mailto:overseasbusiness@uniview.com); [globalsupport@uniview.com](mailto:globalsupport@uniview.com)

<http://www.uniview.com>

©2023 Zhejiang Uniview Technologies Co., Ltd. All rights reserved.

\*Product specifications and availability are subject to change without notice