

8MP LightHunter Fixed IR Dome Analog Camera

UAC-D128-ADF28(40)MS



Introduction

UAC-D128-ADF28(40)MS is a 8MP LightHunter fixed IR dome analog camera with a high-performance 1/2.7-inch CMOS sensor and 3D noise reduction technology. It supports flexible switch among TVI/CVI/AHD/CVBS through DIP switches, effectively enhancing product adaptability and diversity of networking solutions. With SYV-75-3 or other coaxial cable types, the camera can achieve low-cost, long-distance, and anti-interference mega-pixel HD video transmission without time delay. It supports IR-cut filter with auto-switch (ICR) and provides color images at daytime and black/white images at night. The camera also supports audio input and synchronous transmission of audio and video.

Features

- High quality imaging with 8MP resolution
- TVI/CVI/AHD/CVBS
- Supports IR-cut filter with auto-switch (ICR)
- LightHunter monitoring with high-sensitivity sensor
- 3D noise reduction technology delivers clean and sharp images
- Supports 180° horizontal flip, 180° vertical flip
- OSD configuration menu, easy to operate
- IP67 waterproof and dustproof design, high reliability
- OSD configuration menu in 11 languages
- Built-in microphone for high quality audio transmission via coaxial cables

- 120dB true WDR technology enables clear image in strong light scene

Specifications

Model	UAC-D128-ADF28MS	UAC-D128-ADF40MS
Sensor		
Pixel	8MP	
Size	1/2.7"	
Minimum illumination	0.005 lux (F1.6, AGC ON) 0 lux (IR ON)	
Lens		
Lens	2.8mm	4.0mm
Lens mount	M12	
Angle of view	H: 109.1° V: 61.0° D: 126.7°	H: 86.8° V: 49.4° D: 99.9°
Illuminator		
Illuminator	One IR illuminator	
Illumination distance	30m	
Lifetime	≥60,000 hours	
Video		
Resolution	4K: 3840(H) × 2160(V) 5MP@20fps: 2592(H) × 1944(V); 5MP@12.5fps: 2592(H) × 1944(V) 4MP: 2560(H) × 1440(V)	
Frame rate	CVI: 4K@15fps (default), 5MP@20fps, 4MP@25fps, 4MP@30fps TVI/AHD: 4K@15fps, 5MP@20fps, 4MP@25fps, 4MP@30fps CVBS: PAL, NTSC	
Shutter time	PAL: 1/25s-1/50000s NTSC: 1/30s-1/50000s	
Image		
Exposure mode	Four modes: Global (default), BLC, HLC, WDR	
Day/Night	Three modes: Auto (default), Day, Night	
Digital noise reduction	2D/3D	
White balance	Two modes: Auto (default), Manual	
WDR	120dB WDR	
Smart IR	Support	
Flip	Supports 180° horizontal flip, 180° vertical flip	
Defog	N/A	
Audio		
Microphone	Built-in Mic	
Camera audio	CVI: 4K@15fps, 5M@20fps, 4M@25fps, 4M@30fps	
Interface		
Power	5.5mm power interface	
Video output	BNC, supports TVI/AHD/CVI/CVBS	
Operating environment		
Temperature	-30°C to 60°C (-22°F to 140°F)	
Humidity	≤95% (RH, non-condensing)	

Surge protection	4kV
General	
Power	DC 12V ($\pm 25\%$), with reverse polarity protection, Max 3.7W
Mount	Surface mount (default), optional backbox, wall mount bracket
Dimensions	$\Phi 109\text{mm} \times 83\text{mm}$ (diameter*height)
Material	Metal
Weight	395g(0.87lb)
OSD menu language	11 Languages English, German, Spanish(Latin America), French, Italian, Japanese, Korean, Polish, Portuguese(Brazil), Russian, Turkish
Certification	
EMC	CE-EMC (EN 55032,EN 61000-3-3,EN IEC 61000-3-2,EN 55035) FCC (FCC 47 CFR part15 B)
Safety	CE-LVD (EN 62368-1)
Environment	CE-RoHS (2011/65/EU;(EU)2015/863); WEEE (2012/19/EU)
Protection	IP67 (IEC 60529) IK10 (IEC 62262)

Dimensions

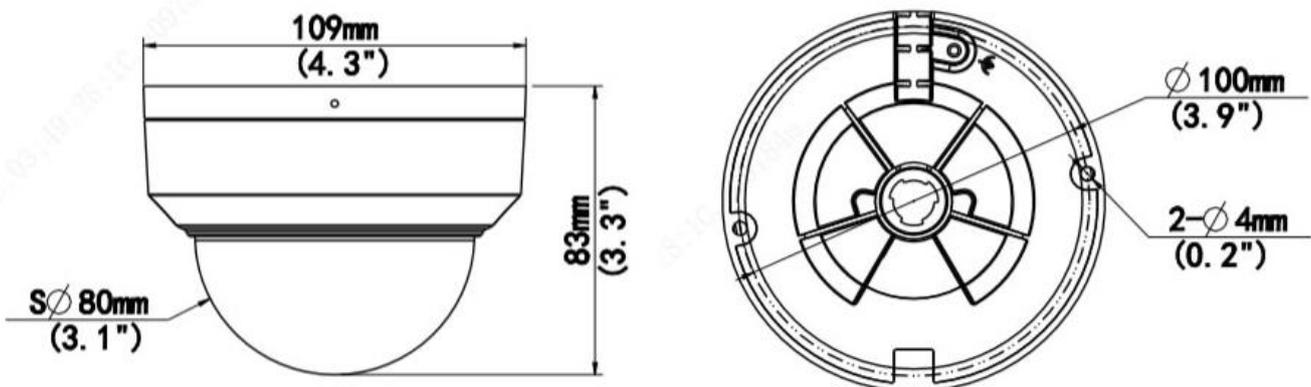

UAC-D128-ADF28(40)MS

Accessories

TR-JB03-G-IN
Junction Box



TR-UC08-C

TR-JB07/WM03-G-IN
Wall Mount



TR-UM06-E-IN

TR-WM03-D-IN
Wall Mount



TR-SE24-IN

TR-A01-IN
Waterproof Joint



TR-SE24-A-IN

TR-UP06-IN
Pole Mount



TR-CM24-IN

Corner Mount



Tilted Mount



Pendant Mount



Pendant Mount



Pendant Mount



PWR-DC1201A-UK,
PWR-DC1201B-UK
Wall Plug-in UK Power
Adapter



PWR-DC1201A-US,
PWR-DC1201B-US
Wall Plug-in US Power
Adapter



PWR-DC1201A-EU,
PWR-DC1201B-EU
Wall Plug-in EU Power
Adapter



PWR-DC1201A-IND
Wall Plug-in IND Power
Adapter

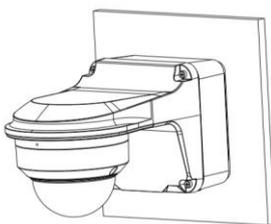
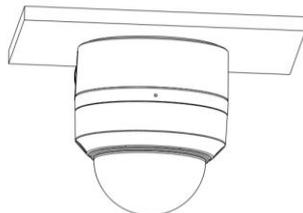
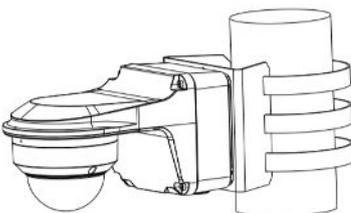
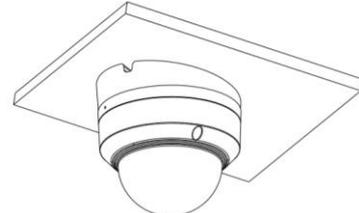
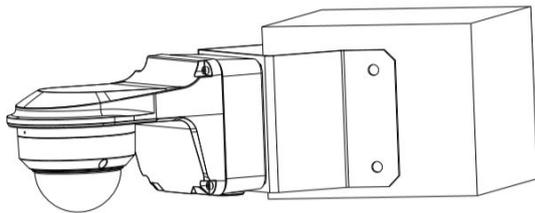
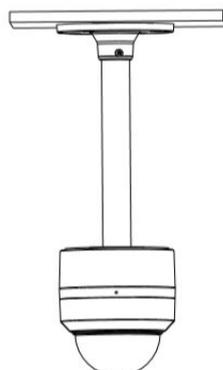

Mount	
TR-JB07/WM03-G-IN 	TR-JB03-G-IN 
TR-JB07/WM03-G-IN(TR-WM03-D-IN)+TR-UP06-IN 	TR-UM06-E-IN 
TR-JB07/WM03-G-IN(TR-WM03-D-IN)+TR-UC08-C 	TR-CM24-IN+TR-JB03-G-IN 

Zhejiang Uniview Technologies Co., Ltd.

Building No. 369, Xietong Road, Xixing Sub-district, Binjiang District, Hangzhou City, Zhejiang Province, China (310051)

Email: overseasbusiness@uniview.com; globalsupport@uniview.com

<https://www.uniview.com>

©2023 Zhejiang Uniview Technologies Co., Ltd. All rights reserved.

*Product specifications and availability are subject to change without notice.