

2MP LightHunter HD IR Fixed Dome Analog Camera

UAC-D122-AF28(40)M



Overview

UAC-D122-AF28(40)M is a 2MP LightHunter HD IR fixed dome analog camera with a high-performance 1/2.9-inch CMOS sensor and 3D noise reduction technology. It supports TVI/AHD/CVI/CVBS, which effectively enhances product adaptability and diversity of networking solutions. With SYV-75-3 or other coaxial cable types, the camera can achieve low-cost, long-distance, and anti-interference mega-pixel HD video transmission without time delay. It supports IR-cut filter with auto-switch (ICR) and provides color images at daytime and black/white images at night. The camera also supports audio input and synchronous transmission of audio and video.

Features

- High quality imaging with 2MP resolution
- TVI/AHD/CVI/CVBS
- Supports IR-cut filter with auto-switch (ICR)
- LightHunter monitoring with high-sensitivity sensor
- 3D noise reduction technology delivers clean and sharp images
- Supports 180° horizontal/vertical flip
- OSD configuration menu, easy to operate
- Water and dust resistant (IP67) and vandal-resistant (IK10)
- OSD configuration menu in 11 languages
- Built-in microphone for high quality audio transmission via coaxial cables
- Supports digital defog
- Metal base and metal housing
- 3-Axis

Specifications

Model	UAC-D122-AF28M	UAC-D122-AF40M
Sensor		
Pixel	2MP	
Size	1/2.9"	
Minimum illumination	0.005 lux (F1.6, AGC ON) 0 lux (IR on)	
Lens		
Lens	2.8mm	4.0mm
Lens mount	M12	
Angle of view	H: 101.5° V: 56.9° D: 117.4°	H: 83.8° V: 42.7° D: 100.1°
Illuminator		
Illuminator	One IR illuminator	
Illumination distance	30m	
Lifetime	≥60,000 hours	
Video		
Resolution	1080P: 1920(H)×1080(V) 720P: 1280(H) ×720(V)	
Frame rate	TVI/AHD/CVI: 1080P@25fps (default), 1080P@30fps; 720P@25fps, 720P@30fps CVBS: PAL, NTSC	
Shutter time	PAL: 1/25s-1/50000s NTSC: 1/30s-1/50000s	
Image		
Exposure mode	Four modes: Global (default), BLC, HLC, DWDR	
Day/Night	Three modes: Auto (default), Day, Night	
Noise reduction	2D/3D	
White balance	Two modes: Auto (default), Manual	
WDR	DWDR	
Smart IR	Support	
Flip	Supports 180° horizontal flip, 180° vertical flip	
Defog	Digital Defog	
Audio		
Microphone	Built-in Mic	
Camera audio	TVI: 1080P@30fps, 1080P@25fps CVI: 1080P@30fps, 1080P@25fps	
Interface		
Power	5.5mm power interface	
Video output	BNC, supports TVI/AHD/CVI/CVBS	
Operating environment		
Temperature	-30°C to 60°C (-22°F to 140°F)	
Humidity	≤95% (RH, non-condensing)	
Surge protection	4kV for power and video output interfaces	
Ingress protection	IP67	
IK rating	IK10	

General	
Power	DC 12V(±25%), with reverse polarity protection, Max 3.3W
Mount	Surface mount (default), optional tilted mounting bracket
Dimensions	Φ109mm*83mm (diameter*height)
Material	Metal
Weight	372g (0.82lb)
Certification	CB, CE, FCC, UL

Dimensions

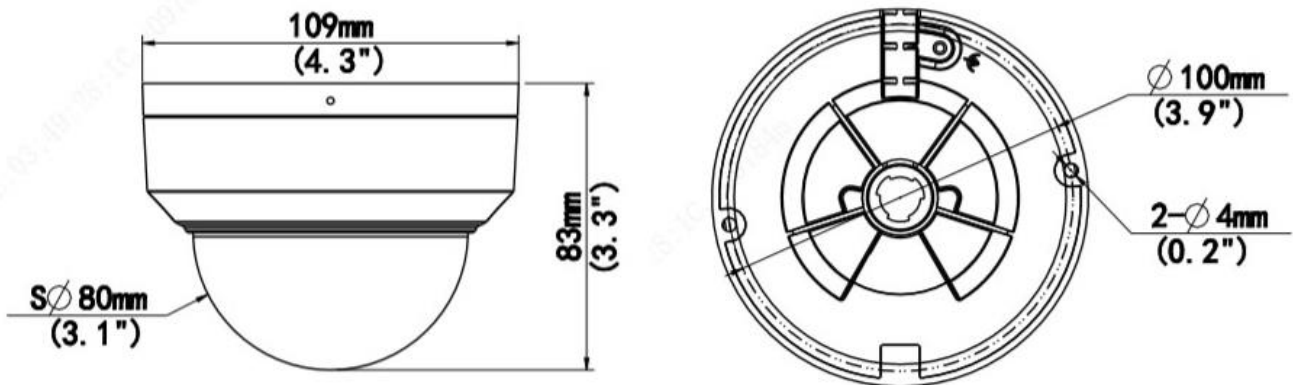

UAC-D122-AF28(40)M

Accessories

TR-JB03-G-IN
Junction Box



TR-JB07/WM03-G-IN
Wall Mount

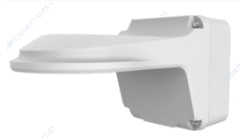

TR-WM03-D-IN
Wall Mount

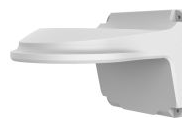

TR-UP06-IN
Pole Mount



TR-A01-IN
Waterproof Joint



TR-UC08-C
Corner Mount

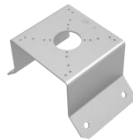

TR-UM06-E-IN
Tilted Mounting



TR-SE24-IN
Pendant Mount



TR-SE24-A-IN
Pendant Mount



TR-CM24-IN
Pendant Mount



PWR-DC1201A-UK
Wall Plug-in UK Power
Adapter



PWR-DC1201A-US
Wall Plug-in US Power
Adapter



PWR-DC1201A-EU
Wall Plug-in EU Power
Adapter



Mount

TR-JB07/WM03-G-IN

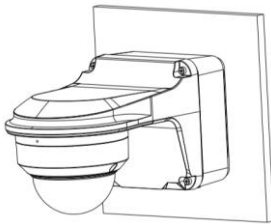

TR-JB03-G-IN

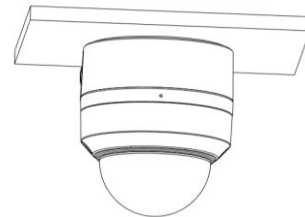

TR-JB07/WM03-G-IN(TR-WM03-D-IN)+TR-UP06-IN

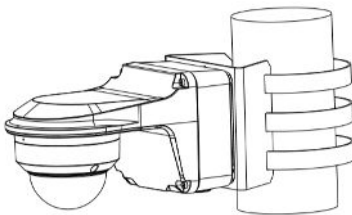

TR-UM06-E-IN

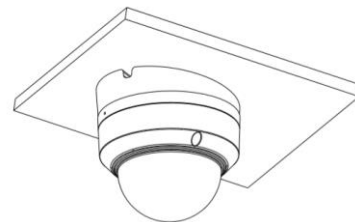

TR-JB07/WM03-G-IN(TR-WM03-D-IN)+TR-UC08-C

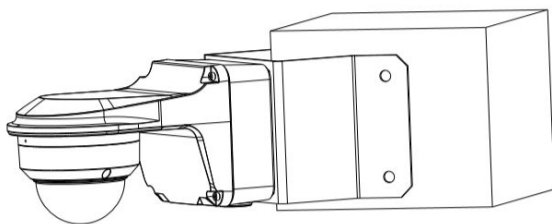

TR-CM24-IN+TR-JB03-G-IN

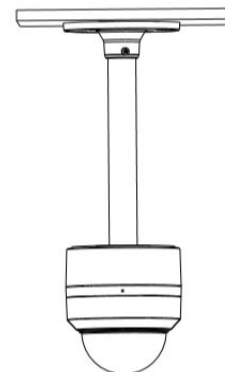

Zhejiang Uniview Technologies Co., Ltd.

Building No. 369, Xietong Road, Xixing Sub-district, Binjiang District, Hangzhou City, Zhejiang Province, China (310051)

Email: overseasbusiness@uniview.com; globalsupport@uniview.com

<https://www.uniview.com>

©2023 Zhejiang Uniview Technologies Co., Ltd. All rights reserved.

*Product specifications and availability are subject to change without notice.