

# **Network Bullet Cameras**

## Quick Guide

Manual Version: V1.01

Thank you for purchasing our product. If there are any questions, or requests, please do not hesitate to contact the dealer.

## Copyright

Copyright 2015 Zhejiang Uniview Technologies Co., Ltd. All rights reserved. No part of this manual may be copied, reproduced, translated, or distributed in any form or by any means without prior consent in writing from our company.

## Trademark Acknowledgement

 and other Uniview's trademarks and logos are the property of Zhejiang Uniview Technologies Co., Ltd. Other trademarks, company names and product names contained in this manual are the property of their respective owners.

## Disclaimer



The default password is used for your first login. To ensure account security, please change the password after your first login. You are recommended to set a strong password (no less than eight characters).

- To the maximum extent permitted by applicable law, the product described, with its hardware, software, firmware and documents, is provided on an "as is" basis.
- Best effort has been made to verify the integrity and correctness of the contents in this manual, but no statement, information, or recommendation in this manual shall constitute formal guarantee of any kind, expressed or implied. We shall not be held responsible for any technical or typographical errors in this manual. The contents of this manual are subject to change without prior notice. Update will be added to the new version of this manual.
- Use of this manual and product and the subsequent result shall be entirely on your own responsibility. In no event shall we be reliable to you for any special, consequential, incidental, or indirect damages, including, among others, damages for loss of business profits, business interruption, or loss of data or documentation, or product malfunction or

information leakage caused by cyber attack, hacking or virus in connection with the use of this product.

- Video and audio surveillance can be regulated by laws that vary from country to country. Check the law in your local region before using this product for surveillance purposes. We shall not be held responsible for any consequences resulting from illegal operations of the device.
- The illustrations in this manual are for reference only and may vary depending on the version or model. As a result, some of the examples and functions featured may differ from those displayed on your monitor.
- This manual is a guide for multiple product models and so it is not intended for any specific product.
- Due to uncertainties such as physical environment, discrepancy may exist between the actual values and reference values provided in this manual. The ultimate right to interpretation resides in our company.



## Environmental Protection

This product has been designed to comply with the requirements on environmental protection. For the proper storage, use and disposal of this product, national laws and regulations must be observed.



## Safety and Compliance Information

### Safety Symbols

The symbols in the following table may be found on installation-related equipment. Be aware of the situations indicated and take necessary safety precautions during equipment installation and maintenance.

Symbol	Description
	Generic alarm symbol: To suggest a general safety concern.
	ESD protection symbol: To suggest electrostatic-sensitive equipment.
	Electric shock symbol: To suggest a danger of high voltage.

The symbols in the following table may be found in this manual. Carefully follow the instructions indicated by the symbols to avoid hazardous situations and use the product properly.

Symbol	Description
	<b>WARNING!</b> Indicates a hazardous situation which, if not avoided, could result in bodily injury or death.
	<b>CAUTION!</b> Indicates a situation which, if not avoided, could result in damage, data loss or

Symbol	Description
	malfunction to product.
	<b>NOTE!</b> Indicates useful or supplemental information about the use of product.

## Safety Information

Installation and removal of the unit and its accessories must be carried out by qualified personnel. Please read all of the safety instructions below before installation and operation.

### Installation

- This device is a class A product and may cause radio interference. Take measures if necessary.
- If the product does not work properly, please contact your dealer. Never attempt to disassemble the camera yourself. (We shall not assume any responsibility for problems caused by unauthorized repair or maintenance.)
- Make sure the power supply voltage is correct before using the camera.
- Do not drop the camera or subject it to physical shock.
- Do not touch sensor modules with fingers. If cleaning is necessary, use a clean cloth with a bit of ethanol and wipe it

gently. If the camera will not be used for an extended period of time, put on the lens cap to protect the sensor from dirt.

- Do not aim the camera lens at the strong light such as sun or incandescent lamp. The strong light can cause fatal damage to the camera.
- The sensor may be burned out by a laser beam, so when any laser equipment is being used, make sure that the surface of the sensor not be exposed to the laser beam.
- While shipping, the camera should be packed in its original packing.
- Use a power adapter or a PoE device that meets requirements. Otherwise, the camera may be damaged.
- Keep the length of the power cord between the power adapter and the camera within 1.5 meters, otherwise, the power voltage on the camera may be lowered and may cause exception. If the power cord is not long enough, extend the part between the power adapter and the power supply.
- Do not move the camera by lifting the tail cable.
- Do not cut the tail cable. Exposed tail cable can cause short circuit and damage the camera.
- Use the waterproof tapes to protect the end of tail cable, and keep the tail cable from water.

- Use the power cable connector delivered with the camera. Make sure the connector is in good condition (clip) and secured into place. Do not fully stretch the power cord, otherwise, the connector may be loose or disconnected due to vibration or shake.
- Use clean and soft cloth dipped with alcohol to wipe the surface when cleaning the camera. Use small amount of neutral detergent when cleaning the lens. Do not use chemicals such as thinner or benzene.
- If the camera is to be mounted on the wall or ceiling, check that the ceiling or wall can bear the weight of the camera.

### **Maintenance**

- If there is dust on the front glass surface, remove the dust gently using an oil-free brush or a rubber dust blowing ball.
- If there is grease or a dust stain on the front glass surface, clean the glass surface gently from the center outward using anti-static gloves or an oil-free cloth. If the grease or the stain still cannot be removed, use anti-static gloves or an oil-free cloth dipped with detergent and clean the glass surface gently until it is removed.
- Do not use organic solvents, such as benzene or ethanol when cleaning the front glass surface.





- Never look at the transmit laser while the power is on. Never look directly at the fiber ports and the fiber cable ends when they are powered on.
- Use of controls or adjustments to the performance or procedures other than those specified herein may result in hazardous laser emissions.

## Regulatory Compliance

### FCC Part 15

This equipment has been tested and found to comply with the limits for digital device, pursuant to part 15 of the FCC Rules. These limits are designed to provide reasonable protection against harmful interference when the equipment is operated in a commercial environment. This equipment generates, uses, and can radiate radio frequency energy and, if not installed and used in accordance with the instruction manual, may cause harmful interference to radio communications. Operation of this equipment in a residential area is likely to cause harmful

interference in which case the user will be required to correct the interference at his own expense.

This product complies with Part 15 of the FCC Rules. Operation is subject to the following two conditions:

1. This device may not cause harmful interference.
2. This device must accept any interference received, including interference that may cause undesired operation.

### LVD/EMC Directive



This product complies with the European Low Voltage Directive 2006/95/EC and EMC Directive 2004/108/EC.

## WEEE Directive–2002/96/EC



The product this manual refers to is covered by the Waste Electrical & Electronic Equipment (WEEE) Directive and must be disposed of in a responsible manner.

# Contents

---

<b>1 Appearance Description.....</b>	<b>1</b>
Dimensions and Appearance .....	1
Camera Structure .....	1
Cable Connection .....	2
<b>2 Installation .....</b>	<b>3</b>
Hardware Installation .....	3
Insert the Micro SD Card (Optional).....	3
Mount Your Camera.....	4
Start the Camera .....	7
Waterproof Measures.....	8
Waterproof Components for RJ45 Plug .....	8
Waterproof Tail Cable .....	10

<b>3 Set Your Camera over the LAN .....</b>	<b>13</b>
<b>4 Access Your Camera .....</b>	<b>14</b>
System Requirements for Your PC .....	15
Access Your Camera .....	16
Install the ActiveX .....	17
Adjust the Display .....	18

# 1 Appearance Description

---

## Dimensions and Appearance

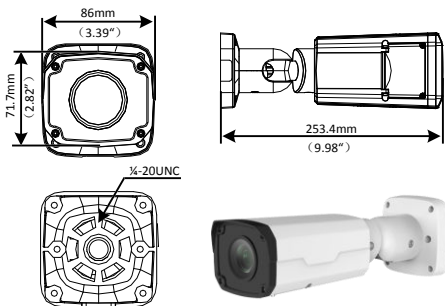

## Camera Structure

All cables are tagged to indicate their functions separately. The tail cable available may vary with the product model. The following examples show cables that are for 12 VDC and 24 VAC.

## Cable Connection

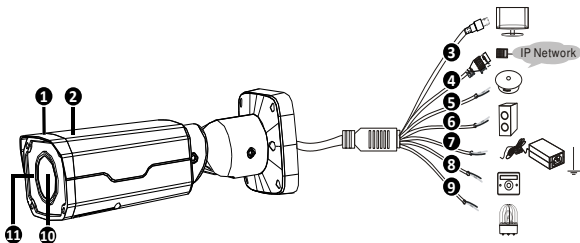

No.	Description	No.	Description
1	Sun shield	2	Housing
3	Video output, BNC interface	4	10M/100M Base-TX adaptive Ethernet interface, RJ45
5	Audio input	6	Audio output
7	Power interface (12 VDC)	8	Alarm input
9	Alarm output	10	Lens
11	IR LED	-	-



For the latest specifications, see the product datasheet.

## 2 Installation

---

### Hardware Installation

#### Insert the Micro SD Card (Optional)

For cameras that support Micro SD, you need to insert the Micro SD card after opening the bottom cover of camera. Do not hot plug the Micro SD card after it is inserted. Otherwise the camera or the SD card might be damaged.

For recommended SD card specifications, contact your dealer.

1. Loosen the cross-recessed screws to open the bottom cover.

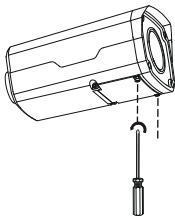



2. Insert the Micro SD card.

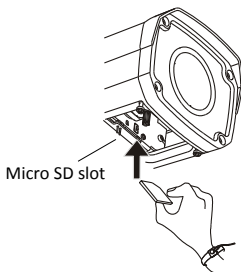

## Mount Your Camera

1. Locate the positions of the holes.

- 1** Paste the installation positioning sticker on the wall and align the cross center to the hole on the wall.

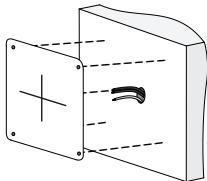

- 2** Lead the cables across the hole on the wall.

## 2. Drill holes on the wall.

Use a  $\varnothing 6.5$  mm drill bit to drill 30 mm-depth guide holes according to the positions marked by the sticker.

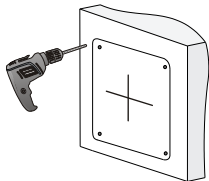

## 3. Mount the plastic anchors of self-tapping screws.

Knock the plastic anchors into the guide holes and ensure that they are tightened up.

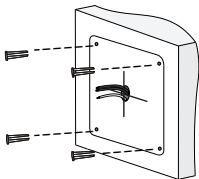

- Loosen the hex fillister-head screw using a 4# hex L-key (that should be purchased separately) to avoid damaging the universal joint.

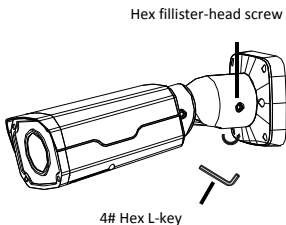

- Mount your camera onto the wall and connect all cables.

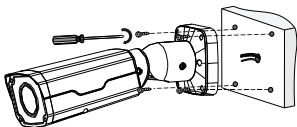

Lead tapping screws through the guide holes in the base and fix them to the wall by using a screwdriver.

## 6. Adjust the monitoring direction.

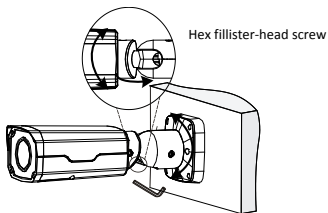

Loosen two hex fillister-head screws using a 4# hex L-key (that should be purchased separately) to avoid damaging the universal joint. Then adjust the camera to the desired monitoring direction. Fasten the screws to finish.

## Start the Camera

Use a power adapter (12 VDC or 24 VAC, not included in the package delivered) to start the camera. After you have mounted the camera properly, connect the camera to power.

## Waterproof Measures

### Waterproof Components for RJ45 Plug

1. Attach the seal ring to the copper interface.

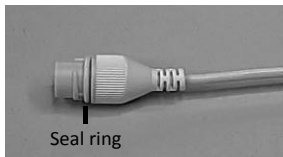

2. Mount the waterproof components.

You can crimp the inner wires of the cable with the RJ45 plug first and then cover the waterproof components. You may also cover the waterproof components first.

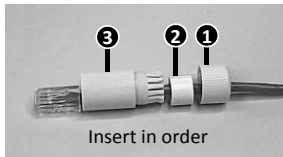

3. Insert the cylindrical waterproof ring into bolt.

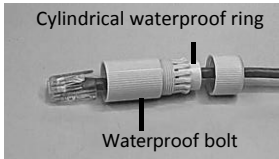

4. Insert the cable into the Ethernet copper interface and screw the waterproof bolt in.



5. Screw in the waterproof bolt lid.



6. Finish the waterproof installation.

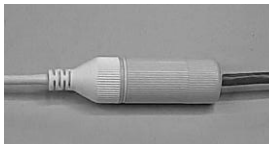

### Waterproof Tail Cable

Connect the tail cables and then take the following steps to protect the tail cables from water using waterproof tapes. The figures are only for illustration purpose.

1. Connect the tail cables.

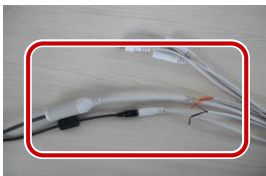

2. Protect the connected cables using insulating tapes.



3. Protect other cables using insulating tapes.



4. Wrap all the tail cables together using insulating tapes.





5. Choose a start point for waterproof tapes.



6. Protect the tail cables using waterproof tapes.





- Avoid short circuit when insulating the cables.
- Use self adhesive waterproof tapes that will stick together with the twisted cables.
- Tighten waterproof tapes when wrapping the cables and make sure the cable connections are fully covered.
- You are recommended to put the waterproof cables in a waterproof junction box which needs to be purchased separately.

## 3 Set Your Camera over the LAN

---

To view and configure your camera via the LAN (Local Area Network), you need to install the EZStation to find your camera and change its IP address.



- Please contact your dealer to obtain the EZStation.
- Please refer to the user manual of EZStation for detailed information.

1. Connect your camera and your PC as shown in the figure below to ensure the routing is available.



2. Use EZStation to search online cameras automatically.
3. Modify the camera settings if necessary, including its IP address and subnet mask.



- The default IP address is “192.168.0.13”. The default username is “admin”, and the default password is “123456”.
- To access your camera from a different subnet, set the gateway for your camera after you log in.

## 4 Access Your Camera

---

You can directly control and manage your camera through the Web on a PC.

## System Requirements for Your PC

Item	Requirements
Operating system	Microsoft Windows 8/Windows 7/Windows XP (32-bit or 64-bit). Microsoft Windows 7 (32-bit) is recommended.
CPU	2.0 GHz or higher, dual-core. Intel i3 CPU or higher is recommended.
Memory	At least 1 GB. 2 GB (or higher) is recommended.
Graphic card	At least 128 MB display memory. Mainstream discrete graphics with more than 1 GB display memory are recommended. The hardware should support DirectX9.0c. <b>Note:</b> Make sure that the latest driver is installed on graphic card.
Sound card	Required. <b>Note:</b> Two-way audio and voice broadcast require the latest driver on sound card.
Network card	Megabit Ethernet network cards (or higher) are recommended.

## Access Your Camera

Before you begin, check that:

- Your camera is operating properly and connected to the network.
- The PC you are using is installed with Internet Explorer 7.0 or later. IE 8.0 is recommended.

Follow these steps to access your camera through the Web interface:

1. Open your browser, input the IP address of your camera (default IP is 192.168.0.13) in the address bar and then press **Enter** to open the login page.
2. Enter the username (default is “admin”) and password (default is “123456”) and then click **Login**.



Install the ActiveX at your first login. For the detailed steps, see [Install the ActiveX](#). When the installation of the ActiveX is completed, open your IE to log in.

## Install the ActiveX

The following takes the IE browser as an example to describe the installation steps.

1. Click **Download**.



Failed to load ActiveX control, click [Download](#) to install latest ActiveX control.

2. Click **Run**. You may also click **Save** to download the file to your computer first.
3. Close the browser and follow the steps to complete the installation.



- For your first login with Windows 7, if the system does not prompt you to install ActiveX, follow these steps to turn off UAC: click the **Start** button, and then click **Control Panel**. In the search box, type **uac**, and then click **Change User Account Control Settings**. Move the slider to the **Never Notify** position, and then click **OK**. After UAC is turned off, log in again.
- If the installation failed, open **Internet Option** in IE before login. Click the **Security** tab, click **Trusted sites**, and then click **Sites** to add the website. If you use Windows 7, you need to save the setup.exe to your PC first, and then right-click the file, select **Run as administrator**, and then install it according to instructions.

## Adjust the Display

Enter the live view page, and then adjust the lens until you get a clear image in the live view page.

BOM: 3101C0BV