

# SPEC ANY TECH. *Configure your fit.*

## Bollards

PRO Bollards™ are sleek, solid, architectural pedestals that integrate smaller tech combinations for flush and surface mount devices into a single stand. Great for lobbies and entryways. With a superior anchor solution they will withstand all the traffic and abuse your visitors can inflict. An excellent choice for security consultants and integrators around the world.

### PRODUCT FEATURES

- Specify any access control device(s)
- Attractive, modern architectural design
- Available in aluminum, carbon steel, or stainless steel
- Standard 2"-6" depth, up to 3"-8" widths available
- Removable "small, hand access" back panel
- Internal .25" base plate, "no wobble" superior anchoring
- No visible fasteners after installation
- Easily customizable
- Free custom CAD designs in 24 hours
- Fast installation process
- Made in the USA



### Areas of Use

- Multi-Tenant Units
- Premier Office & Lobby
- Gate Ingress/Egress

### QUICK FEATURE COMPARISON

	Made from	Removable back panel	Top	Widths	Customization
<b>BOLLARDS</b>	Metal tubes	Small hand access	Flat or tapered	Limited 8" or less	Limited, dependent on tube mill dimensions
<b>CABINETS</b>	Sheet metal	Full access	Flat	Unlimited 8"+	Unlimited & profile dimensions

## Square

## Round

### ALUMINUM

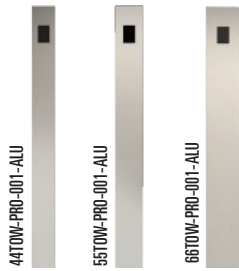

### STAINLESS STEEL

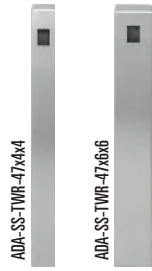

### STAINLESS STEEL

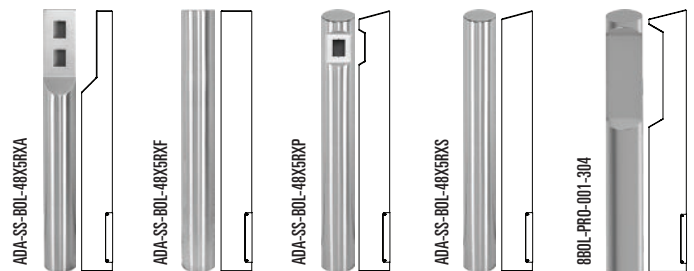

## Rectangle

### ALUMINUM



### STAINLESS STEEL



### CARBON STEEL



### MATERIAL OPTIONS

- Carbon Steel
- #304 Stainless Steel
- #316 Stainless Steel
- Aluminum

### STAINLESS FINISH

- Brushed #4

### POWDERCOAT FINISHES

- STANDARD COLORS**
- Black Wrinkle
  - White
  - Safety Yellow

- READILY AVAILABLE METALLIC COLORS**
- Silver Sky Metallic\*
  - Oil-Rubbed Bronze\*
  - Anodized Aluminum\*
  - Nickel\*

### CUSTOM "RAL" COLORS AVAILABLE\*\*



\*short lead times and additional costs may apply  
\*\* additional costs and lead times apply

## Technical Specs

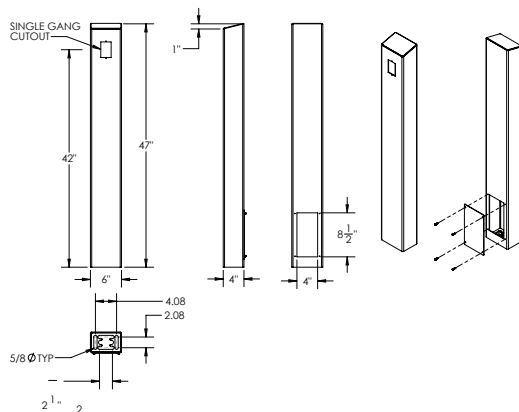

### NEED MORE?



Scan the QR code to access downloadable PDF and DWG drawings available to registered architects and engineers at [pedestalpro.com](http://pedestalpro.com).

## Accessories

### FAN



### HEATER



### LED



### L BOLT



### ANCHORS



### SHIMS



# Bollard Style Pedestals

## Key Features

### STAINLESS STEEL

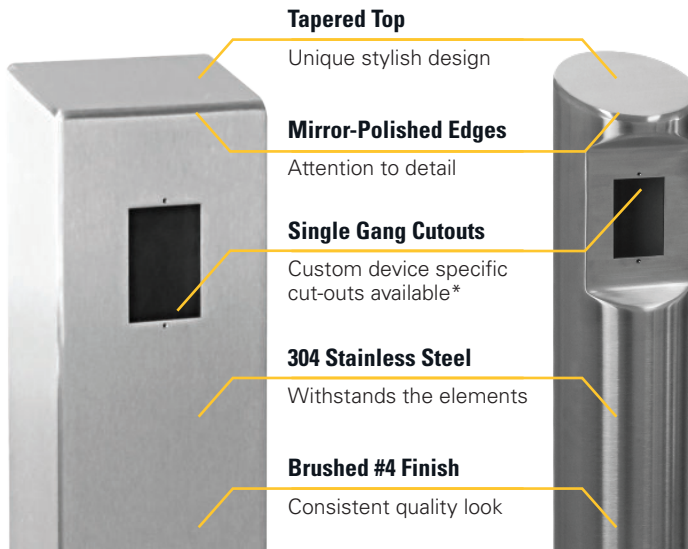

### ALUMINUM



### ALL MODELS:

#### Removable Access Panel

Ease of installation

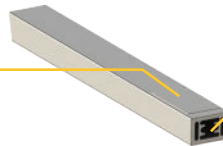

#### Hidden Fasteners

Contribute to the sleek design

## Part Numbers

Rectangle Bollards	Hgt	Wdth	Dpth	Wgt	Material	Finish	Description	Cutouts Included	Mnt Hgt
ADA-CS-TWR-47x4x6	47"	6'	4"	35 lbs	Carbn Stl	Powdercoat - Black Wrinkle	47" Stl Twr, Arch, Blck	Single Gang	42
ADA-SS-TWR-47x4x6	47"	6'	6"	35 lbs	304 SS	Brushed #4	47" Stl Twr, Arch, Blck (6" face)	Single Gang	42
ADA-SS-TWR-47x4x6-2	47"	6'	6"	35 lbs	304 SS	Brushed #4	47" Stl Twr, Arch, Blck (6" face)	2 Single Gang	36, 42
ADA-SS-TWR-47x4x6-2	47"	6'	6"	35 lbs	304 SS	Brushed #4	47" Stl Twr, Arch, Blck (6" face)	3 Single Gang	36, 42
ADA-SS-TWR-47x4x6-3	47"	6'	6"	35 lbs	304 SS	Brushed #4	47" Stl Twr, Arch, Blck (6" face)	Single Gang	29, 36, 42
ADA-SS-TWR-47x4x8	47"	6'	8"	75 lbs	304 SS	Brushed #4	47" Stl Twr, Arch, Blck (8" face)	Single Gang	42
ADA-SS-TWR-54x8x4Z	54"	6'	8"	85 lbs	304 SS	Brushed #4	47" Stl Twr, Arch, Blck (8" face)	Single Gang	48
ADA-SS-TWR-60x4x6	60"	6'	6"	45 lbs	304 SS	Brushed #4	47" Stl Twr, Arch, Blck (6" face)	Single Gang	45
ADA-SS-TWR-72x4x6	72"	6'	6"	55 lbs	304 SS	Brushed #4	47" Stl Twr, Arch, Blck (6" face)	Single Gang	66
64TOW-PRO-001-ALU	47"	6'	6"	30 lbs	Alum	Powdercoat "Anodized Alum"	47" Stl Twr, Arch, Blck (6" face)	Single Gang	42
84TOW-PRO-001-ALU	47"	6'	8"	30 lbs	Alum	Powdercoat "Anodized Alum"	47" Stl Twr, Arch, Blck (8" face)	Single Gang	42

Square Bollards	Hgt	Wdth	Dpth	Wgt	Material	Finish	Description	Cutouts Included	Mnt Hgt
ADA-SS-TWR-47x4x4	47"	4'	4"	29 lbs	304 SS	Brushed #4	47" Stl Tower, Arch (4" face)	2 Single Gang	42
ADA-SS-TWR-47x6x6	47"	6'	6"	45 lbs	304 SS	Brushed #4	47" Stl Tower, Arch (6" square)	Single Gang	42
44TOW-PRO-001-ALU	47"	4'	4"	20 lbs	Alum	Powdercoat "Anodized Alum"	47" Stl Tower, Arch (4" face)	Single Gang	42
55TOW-PRO-001-ALU	47"	5'	5"	25 lbs	Alum	Powdercoat "Anodized Alum"	47" Stl Tower, Arch (5" face)	Single Gang	42
66TOW-PRO-001-ALU	47"	6'	6"	35 lbs	Alum	Powdercoat "Anodized Alum"	47" Stl Tower, Arch (6" face)	Single Gang	42

Round Bollards	Hgt	Wdth	Dpth	Wgt	Material	Finish	Description	Cutouts Included	Mnt Hgt
ADA-SS-BOL-48X5RXA	48"	5'	5"	35 lbs	304 SS	Brushed #4	48" Stl Bollard, Arch (flat top)	Single Gang	38.5, 43.5
ADA-SS-BOL-48X5RXF	48"	5'	5"	35 lbs	304 SS	Brushed #4	48" Stl Bollard, Arch (flat top)	None (cutouts can be added)	-
ADA-SS-BOL-48X5RXP	48"	5'	5"	35 lbs	304 SS	Brushed #4	48" Stl Bollard, Arch, Blck (slanted top)	Single Gang	40.5
ADA-SS-BOL-48X5RXS	48"	5'	5"	35 lbs	304 SS	Brushed #4	48" Stl Bollard, Arch, Blck (slanted top)	None (cutouts can be added)	-
8BOL-PRO-001-304	56"	8'	8"	79 lbs	304 SS	Brushed #4	56" Stl Bollard, Arch, Blck (8" round)	None (cutouts can be added)	-

Accessories	Description	Accessories	Description
ACC-FAN-001-304	Pedestal Cooling Fan (12 VDC/2amp power supply included)	STUD-ANCHOR-625	5/8" Stud Anchor Kit (for existing construction)
ACC-LED-001	Pedestal LED Light Kit (12 VDC/2amp power supply included)	L-BOLT-625	5/8" L-Bolt Mounting Kit (for new construction)
ACC-HEA-001-304	Pedestal Heater Kit 250W (Fits bollard dimensions 4x4 or larger)	Shim-Kit-001	Leveling Shim Kit: 1/16", 1/8", 1/4" (2 each)

## Bollard Options

### TECH INTEGRATION

Integrate intercoms, keypads, card readers, cameras and more from our vast device library representing over 35 OEM brands and 400+ devices. Our engineers are ready to incorporate your tech into our bollards. We also offer in-house cooling fans, heaters, LED lighting, and weather shrouds solutions to meet all your tech integration needs.



### FREE CUSTOM CAD

CAD engineers are free to use and on-call to create drawings specific to your project requirements. CAD designs are created within 24 hours.

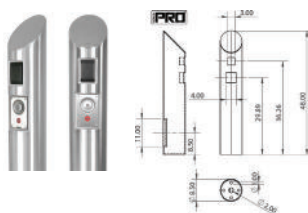

### EXPEDITED FABRICATION

12 – 15 days	Standard, no additional charge
10 – 11 days	15% fee
8 – 9 days	25% fee
6 – 7 days	45% fee
4 – 5 days	65% fee
2 – 3 days	100% fee

*Business days exclude weekends and holidays, does not include shipping costs or timelines.*

## Product Categories



## Why Pedestal PRO

### CUSTOMIZATION ■ QUICKEST TURNAROUND ■ HIGHEST QUALITY

With more than 500,000 installations worldwide, including projects for Fortune 100 companies, Pedestal PRO manufactures unique mounting solutions to support consultants, integrators, and installers in the security industry.

Using the most precise device integration methods available, Pedestal PRO custom designs premium pedestals, housings, and mounts to accommodate any physical security device or technology specified by its customers.

Recommended readily-available materials, expedited production timelines, and on-time delivery ensures total satisfaction for every project, every time.

