

PRODUCT FEATURES

- Designed for security professionals
- Black wrinkle powder coating w/ UV protection
- Universal design
- Heavy duty 14-gauge material
- Steel construction
- Military-grade EPDM rubber seal
- #304 Stainless steel hinge
- 3" Backbox space
- 3" Weather/privacy shroud
- Removable door
- Cam lock included
- Knockouts on backside
- IP54 rating
- NDAA, Buy American, or USMCA/CUSMA compliant
- In-stock, ready-to-ship
- Available direct or through distribution

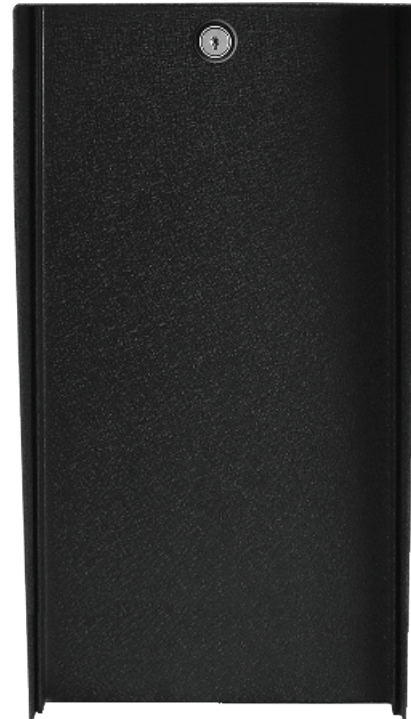

CUSTOM OPTIONS

- Factory cutouts available for your devices
- Shorten or extend height, width, or depth
- Readily available powder coating colors (white, yellow, bronze, gray, silver)
- Choose any RAL powder color

DESCRIPTION

A sturdy steel housing to combine one or more access control devices such as keypads, card readers, intercoms, and entry/exit buttons side by side. Mount on a wall or pedestal at a gate, lobby, or entryway. Outdoor rated with weather/privacy shroud, EPDM rubber seal, stainless steel hinge, and polyester powder coating with UV inhibitor. Convenient knockouts on the backside. Cam lock included. Door is removable.

RECOMMENDED ACCESSORIES

ROTATING HEAD



OMNI-4W5T-BLK

BUFFER PLATE



46PLA-PRO-001-HDP

HEATER



ACC-HEA-001-304

COOLING FAN



ACC-FAN-001-304

LIGHT KIT



ACC-LED-001

NOTE: Real time inventory levels are viewable for registered users on pedestalpro.com

Model No. **Portra-CS-8x16-E**

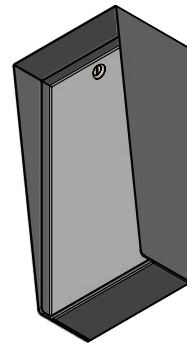
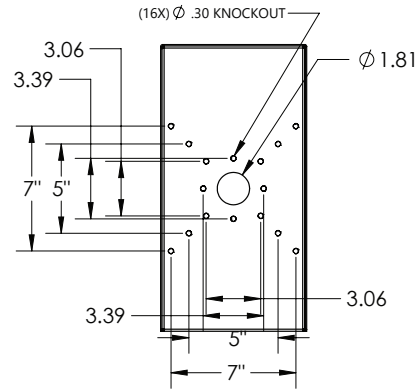
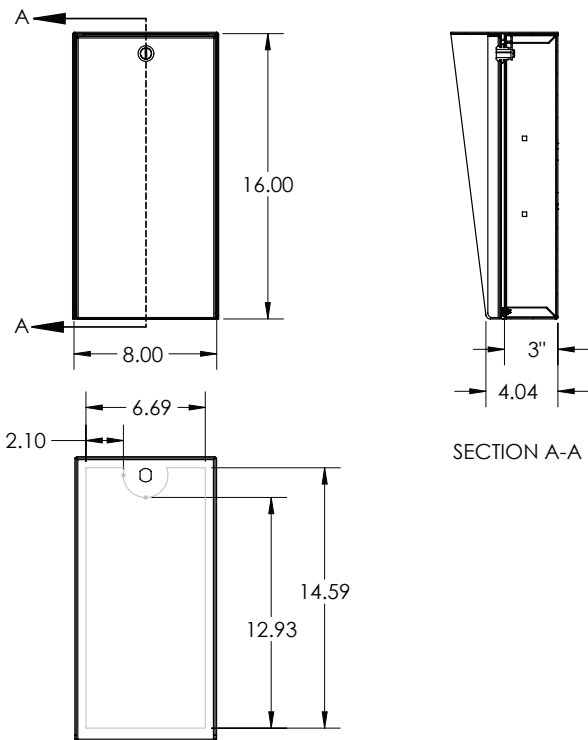

NOTE: CAD drawing available online.
Scan for more detail.

DATA & SPECS

| | |
|------------------|--|
| Product Style | Housing |
| Material | Steel, .0749" (14 gauge) |
| Tube | #304 Stainless steel |
| Face Plate | EPDM rubber |
| Base Plate | IP54 |
| Cover Plate | Yes |
| Mounting Method | Knockouts, qty 4+ |
| Pretreatment | High pressure/high temperature phosphate wash and rinse |
| Finish | Black wrinkle powder coating (TGIC outdoor polyester) |
| UV Protection | Yes |
| Hardware | none |
| Packaging | Foam wrapped and boxed individually |
| Package Size | 17 x 9 x 7 |
| Weight | 13 lbs |
| Shipping Method | UPS, FedEx, or LTL freight |
| Compliance | NDA, Buy American, or USMCA/CUSMA (see website for details) |
| Warranty | 1 year limited (see website for details) |
| Inventory Status | In-Stock (inventory levels viewable for registered users on pedestalpro.com) |

SIMILAR PRODUCTS

