

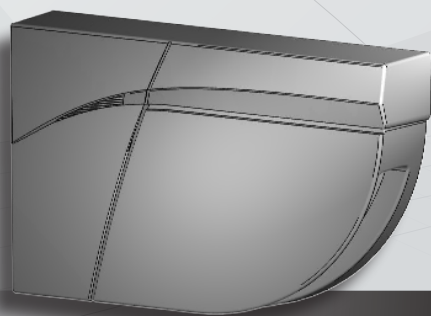

Visit website for  
available languages  
of this document.



EN



# LZR<sup>®</sup>-FLATSCAN SW

SAFETY SENSOR FOR FULL- AND LOW-ENERGY  
AUTOMATIC SWING DOORS



## DESCRIPTION

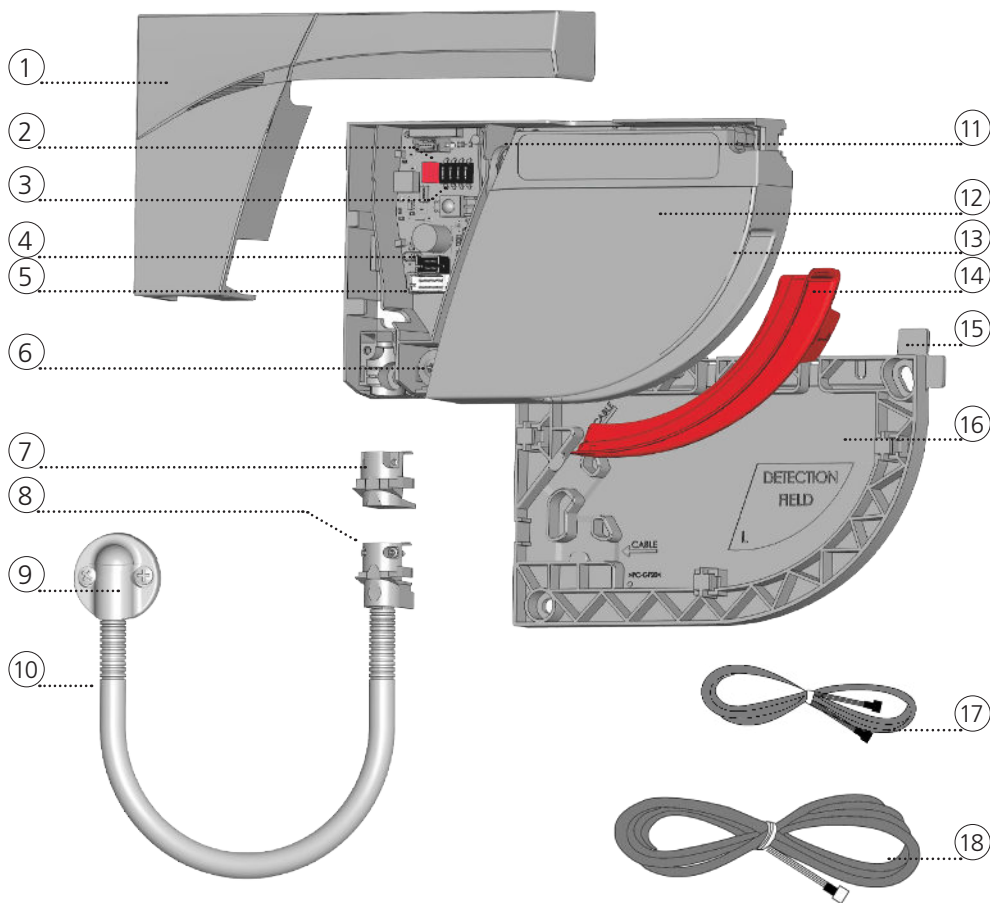

- |    |                             |     |                |     |                         |
|----|-----------------------------|-----|----------------|-----|-------------------------|
| 1. | cover                       | 7.  | plug           | 13. | laser window            |
| 2. | push button                 | 8.  | clamp          | 14. | laser window protector  |
| 3. | DIP switch                  | 9.  | cap and screws | 15. | positioning tabs        |
| 4. | Primary-Secondary connector | 10. | door loop      | 16. | mounting base           |
| 5. | main connector              | 11. | lock screw     | 17. | Primary-Secondary cable |
| 6. | angle adjustment screw      | 12. | laser head     | 18. | power cable (20.5433)   |

## LED SIGNALS

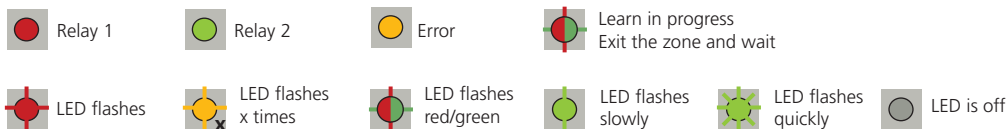

# READ BEFORE BEGINNING INSTALLATION/PROGRAMMING/SET-UP



**THIS SENSOR IS POWERED BY DC VOLTAGE ONLY.**  
SEE PAGE 6 (step 7) FOR INFORMATION REGARDING USE OF A RECTIFIER.

## INSTALLATION TIPS

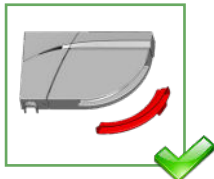

Remove the laser window protection before teach-in and commissioning.

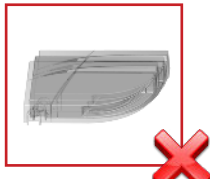

Avoid vibrations.

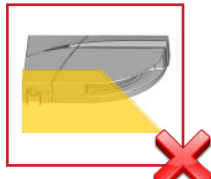

Do not cover the laser window.

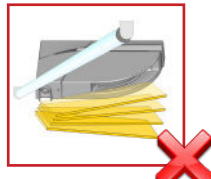

Avoid moving objects and light sources in the detection field.



Avoid the presence of smoke and fog in the detection field.



Avoid condensation.

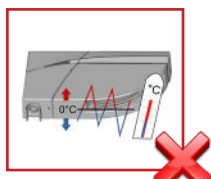

Avoid exposure to sudden and extreme temperature changes.

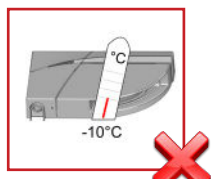

Ensure power to the sensor in areas where the temperature can reach below -10 °C.

## MAINTENANCE TIPS

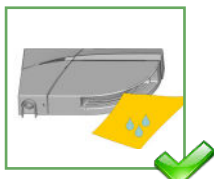

When needed, wipe the laser window only with a soft, clean and damp microfiber cloth.



Do not use dry or dirty towels or aggressive products to clean the laser window.



Avoid direct exposure to high-pressure cleaning.

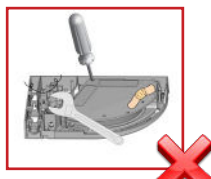

The warranty is invalid if unauthorized repairs are made or attempted by unauthorized personnel.

## SAFETY TIPS

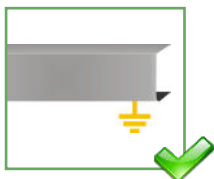

The door control unit and the header cover profile must be correctly grounded.



Only trained and qualified personnel are recommended to install and set up the sensor.



Always test for proper operation before leaving the premises.

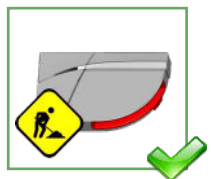

Do not remove the laser window protection if building works are still in progress on site.

# 1 MOUNTING

**⚠** Full-energy applications require a sensor on each side of the door in order to comply with ANSI 156.10. Low-energy applications may use only one sensor on the approach side.

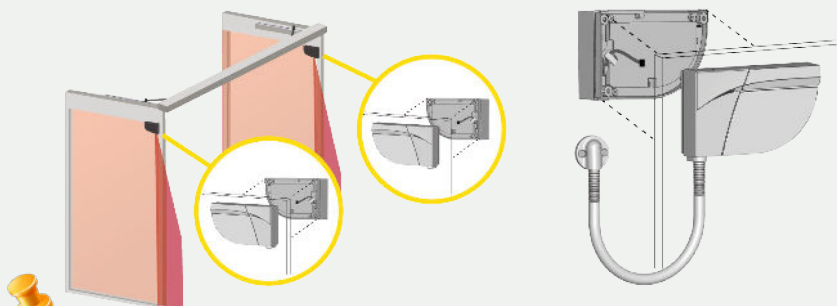

For applications requiring a spacer, first mount spacer to door, and then mount mounting base to spacer.

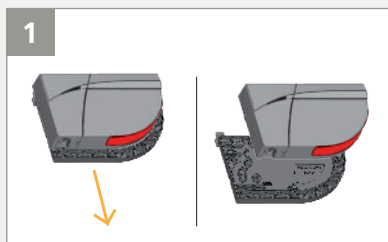

Slide the mounting base off of the sensor.

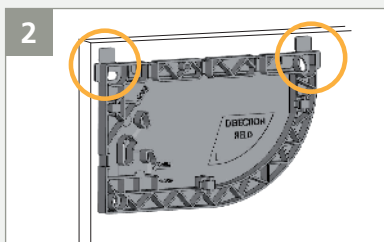

Position the mounting base on the door. Use the positioning tabs to align the base correctly.

**⚠** When mounting the mounting base, ensure the sensor will not interfere with door movement. If the sensor isn't correctly positioned, it could be damaged during door opening/closing.

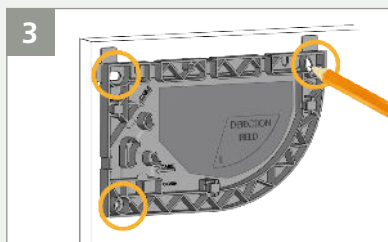

Mark the pilot holes on the door. You can also use the inner surface of the mounting base to fasten the screws.

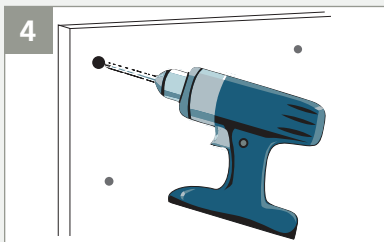

Drill pilot holes  $\frac{1}{8}$ " for sensor mounting.

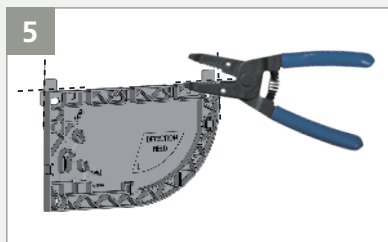

Using a wire cutter, remove the positioning tabs from the mounting base.

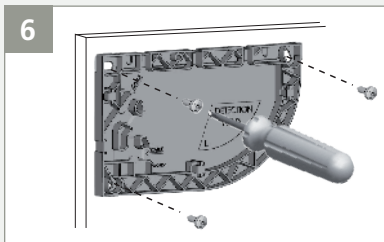

Fasten the 3 screws using a screwdriver.

# 1 MOUNTING (cont.)

If installing only one sensor (low-energy, approach side), skip steps 7, 8, 10, 11, 12, and 13.

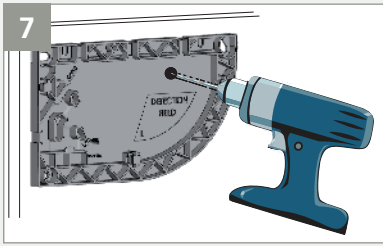

Drill a  $\frac{5}{16}$ " pass-thru hole in the mounting base and door. Sand down any rough edges.

For UL10 compliance, ensure the hole is offset a minimum of 1 inch from the hole on the other side of the door.

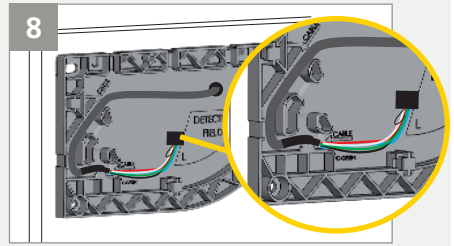

Pass the Primary/Secondary cable through the hole and then position the cable in the notch of the mounting base and secure.

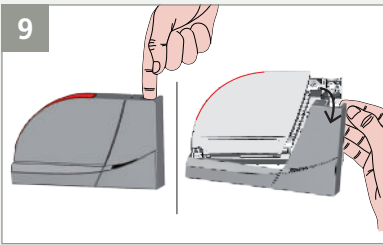

Remove the sensor cover by inserting your finger and then pull firmly towards you.

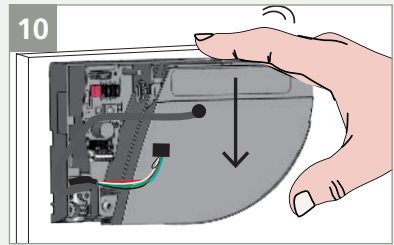

Pass the cable through the hole on the back of the sensor and secure the sensor to the mounting base by sliding it downward.

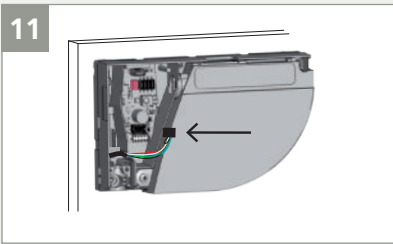

Connect the black plug to the black connector.

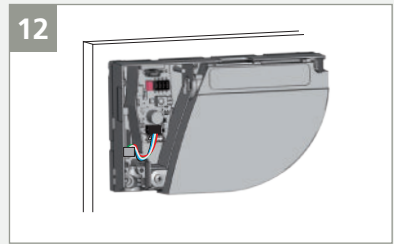

Ensure all wires are secured within the notch to avoid damage from the cover.

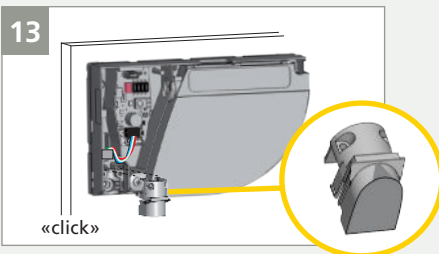

Use a plug to close the Secondary sensor.

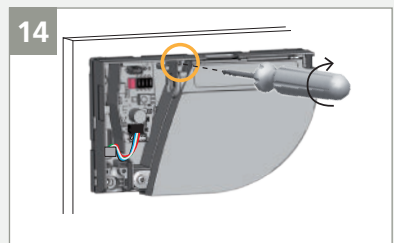

Secure the lock screw to avoid vibrations during door movement.

## 2 WIRING

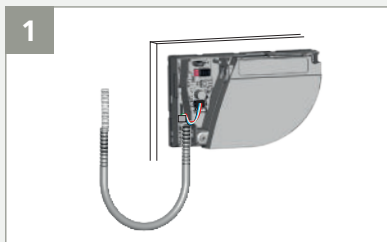

Determine the appropriate length for the door loop.

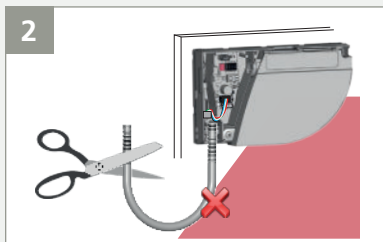

Cut excess door loop to avoid obstructions.

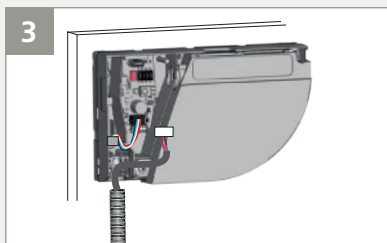

Pass power cable through door loop and connect white plug to white connector. *Ensure that the loop does not interfere with the sensor view.*

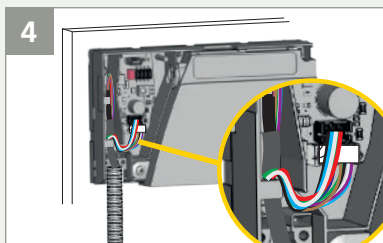

Create a loop with the wires of the power cable and pass them through the notch as indicated. Use the other part of the cable to block the wires.

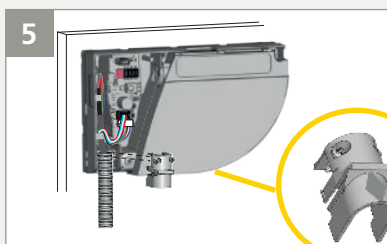

Secure the door loop to the sensor, using the clamp. Secure the 2 screws to avoid pulling out the cable.

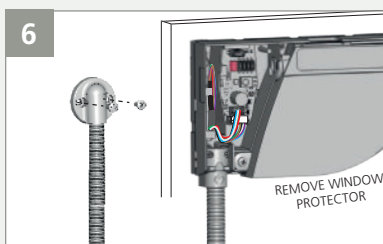

Tighten the other side of the door loop using the cable cap and pass through the remaining length of the power cable towards the door controller.

### 7 **Cut the power cable to the correct length, strip the 10 wires, and connect as indicated above.**

12-24 VDC <sup>1</sup>	RED	+	POWER SUPPLY
	BLACK	-	
NO/NC <sup>2</sup>	BLUE	OUTPUT 1	STOP IMPULSE
COM	BROWN	STOP	Swing side of the door
NO/NC <sup>2</sup>	GREEN	OUTPUT 2	REOPENING IMPULSE
COM	WHITE	REOPEN	Approach side of the door
	GRAY <sup>3</sup>		
	GRAY <sup>3</sup>		
	PURPLE		
	PURPLE	TEST	

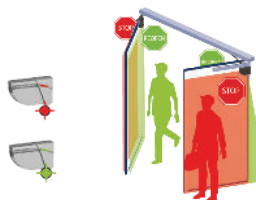

<sup>1</sup> If only VAC power is available, a 12V transformer paired with a rectifier must be used. Do not use a 24V transformer and rectifier as this will cause damage to the product.

<sup>2</sup> Output status when sensor is operational (can be NO or NC; NO= default). See page 10.

<sup>3</sup> Not used.

### 3 DIP SWITCHES

#### ON (switch ↑)



RELAY 1: STOP-impulse on swing side of door

#### OFF (switch ↓)

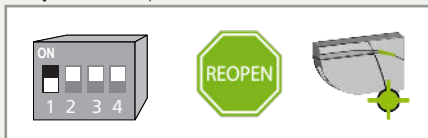

RELAY 2: REOPENING-impulse on approach side of door

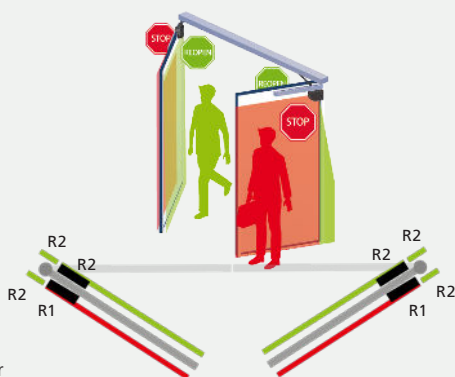

ORANGE



GREEN



OFF

> 3 sec.

After changing a DIP switch, the orange LED flashes.

A LONG push on the push button confirms the settings.

Afterwards, a number of green flashes (x) indicates the number of connected sensors (x).

### 4 TEACH-IN



Before launching a teach-in, ensure the following:

- door is closed (use Service Mode if needed – see page 8)
- both relays are connected to door control and Primary/Secondary cable is connected between sensors
- detection field is free of environmental obstructions, objects, and people
- laser window protector is removed
- **verify the relay output setting (see page 10)**

**NOTE:** A teach-in on the Primary configures both the Primary and the Secondary. A teach-in on the Secondary only configures the Secondary. In case the Primary and Secondary sensor are not aligned, first launch a teach-in on the Primary and then on the Secondary.

1. Press the Primary sensor push-button briefly. The LED will begin quickly flashing red/green. When installing the sensor on a pair of doors, repeat this on the second Primary sensor.
2. When both sensors flash green, position yourself in front of the door and stretch out your arm in front of you. Make an up-and-down motion at the leading-edge to mark the limit of the detection zones. The LED will flash red while calculating the width of the door leaves.
3. When the sensors flash green again, remove yourself from the detection field and cycle the door open to allow the sensors to learn the environment. The sensors will flash red during the closing of the door.
4. Once the door is completely closed again and the LED is off, the teach-in is complete.

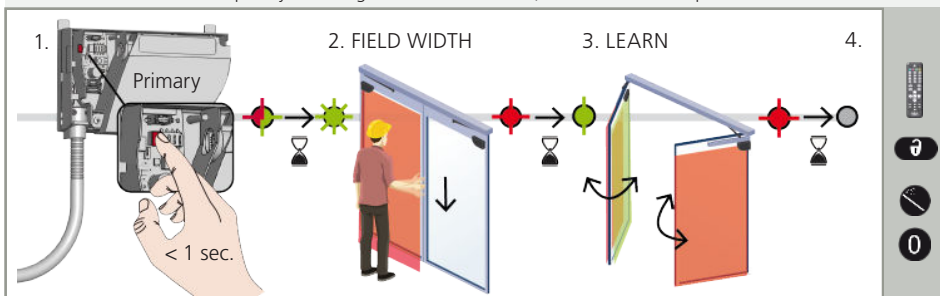

## 5 TESTING AND ADJUSTING



Check the correct positioning of the safety fields by walk-testing according to ANSI 156.10 standards.

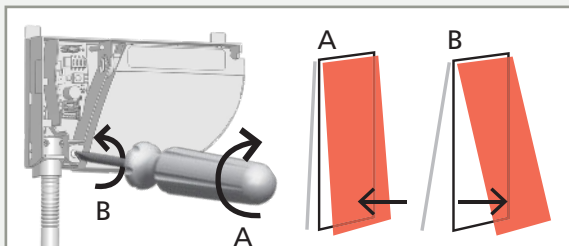

If necessary, adjust the tilt angle of the laser curtain by turning the tilt angle adjustment screw (from 2° to 10°).



Always launch a teach-in and test the correct positioning of the detection fields after making adjustments to the angle, sensor position, or environment.

Verify that the sensor correctly detects based upon the ANSI 156.10 walk test. Make appropriate adjustments to the sensor and/or door control, if necessary, to ensure that the system is ANSI-compliant.

## 6 FINAL STEPS

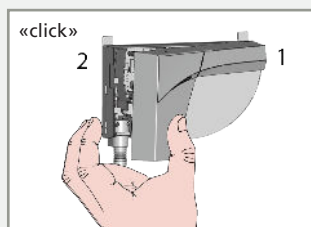

Apply the cover starting on the narrow side. Do not hesitate to push.



To remove the cover, position a screwdriver in the notch and pull upwards until the cover loosens.

Watch our LZR-FLATSCAN SW tutorial online: [bea-flatscan.com/tutorial](http://bea-flatscan.com/tutorial)



## ! SERVICE MODE

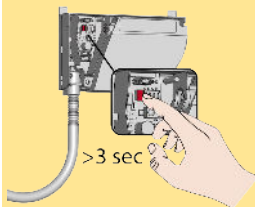

Service Mode **deactivates all detection fields** for 15 minutes and can be useful during an installation, a mechanical learn of the door, or maintenance work.

- To enter Service Mode, push and hold the button for at least 3 seconds. The LED will turn off.
- To exit Service Mode, push and hold again for at least 3 seconds.

Service Mode is deactivated automatically when a teach-in is launched.





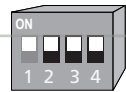

## ADDITIONAL DIP SWITCH SETTINGS



		ON	OFF	
DIP 2	ENVIRONMENT	standard	critical	Switch to CRITICAL when external disturbances are likely to cause unwanted detections (min. obj size, immunity, and uncovered zone are increased).
DIP 3	OUTPUT CONFIGURATION	N.O./N.O. <sup>1</sup>	N.C./N.C. <sup>1</sup>	Settings for this DIP switch must be set on the Primary sensor (i.e. the sensor connected to the door control).
DIP 4	PINCH ZONE	on	off	Switch to OFF when the hinge area does not need to be secured and objects can cause unwanted detections.

### NOTES:

1. RELAY 1 / RELAY 2







After changing a DIP switch, the orange LED flashes. A LONG push on the push button confirms the settings. Afterwards, a number of green flashes (x) indicates the number of connected sensors (x).

> 3 sec.

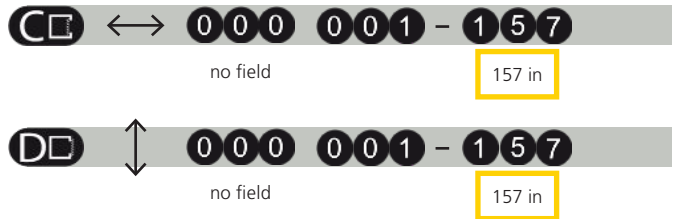
## ADDITIONAL REMOTE CONTROL SETTINGS

= FACTORY VALUE



A teach-in overwrites these values automatically.

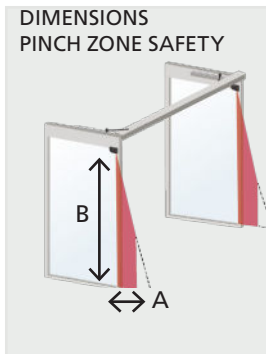

**DIP 4 must be set to ON to modify settings using the remote control.**

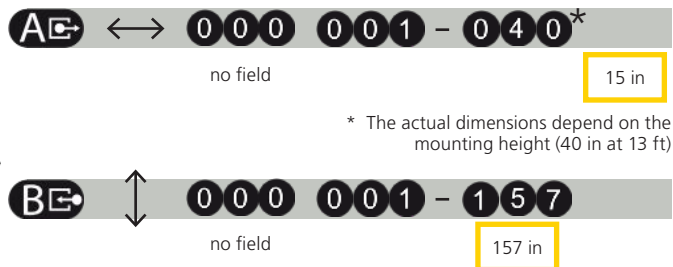

A teach-in overwrites these values automatically.

## ADDITIONAL REMOTE CONTROL SETTINGS

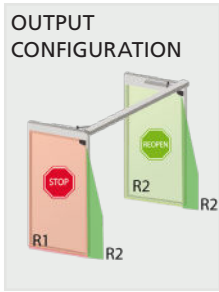

**DIP 3 must be set to ON to modify settings using the remote control.**

		1	2	3	4		
	R1	NO	NC	NC	NO	NO	NC
	R2	NC	NO	NC	NO	NO	NC

NO POWER   
 NO DETECTION   
 DETECTION

NO = normally open  
NC = normally closed

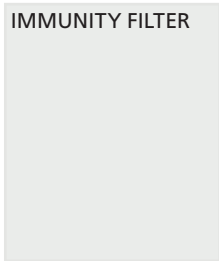

**DIP 2 must be set to ON to modify settings using the remote control.**

Increase to filter out external disturbances.

	1	2	3	4	5	6	7	8	9
	low	>	>	>	>	>	>	>	high

The reaction time increases significantly between value 5 and 9.



**DIP 2 must be set to ON to modify settings using the remote control.**

Increase in case of environmental obstructions.

F2	1	2	3	4	5	6	7	8	9
	0.75	1.5	2.25	3.0	4.0	4.75	5.5	6.25	7.0

Measured in inches, in specific conditions and dependent on application and installation.

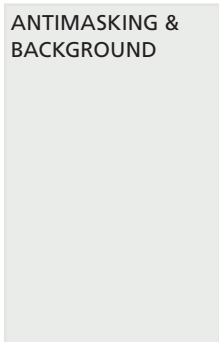

**Antimasking:** protective function which detects an unwanted object nearby the laser window masking the vision field.

**Background:** reference point in the detection field of the sensor. If no background is present, switch to off.

	0	1	2	3
	OFF	OFF	ON	ON
	OFF	ON	OFF	ON

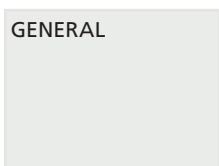

	0	8	9
	teach-in	full reset	partial reset
	see page 7	factory reset of all values	factory reset of all values except field dimensions and output configurations

## HOW TO USE THE REMOTE CONTROL



After unlocking, the red LED flashes and the sensor can be adjusted by remote control.



If the red LED flashes quickly after unlocking, you need to enter an access code from 1 to 4 digits. If you do not know the access code, **cycle the power**. During 1 minute, you can access the sensor without introducing any access code.



To end an adjustment session, always lock the sensor.



It is recommended to use a different access code for each sensor in order to avoid changing settings on both sensors at the same time.

### SAVING AN ACCESS CODE

The access code is recommended for sensors installed close to each other.



### DELETING AN ACCESS CODE



### ADJUSTING ONE OR MORE PARAMETERS



### CHECKING A VALUE

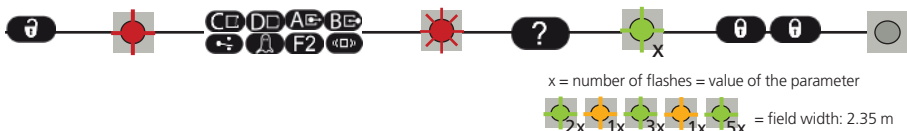

### RESTORING TO FACTORY VALUES



## DETECTION FIELDS

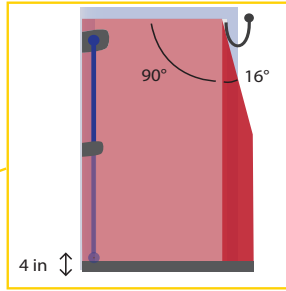
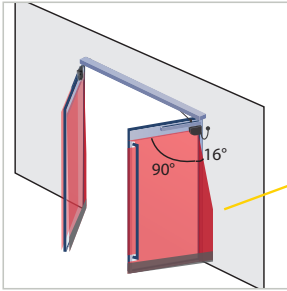

- DOOR LEAF SAFETY  
Typ. object size: 4 inches at 13 feet
- PINCH ZONE SAFETY  
Typ. object size: 3/4 inch at 13 feet
- UNCOVERED ZONE  
*adjustable by remote control*  
factory value: 4 inches

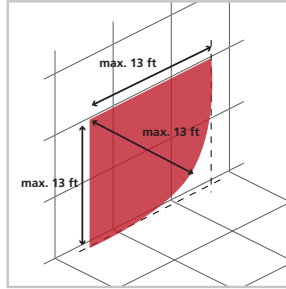
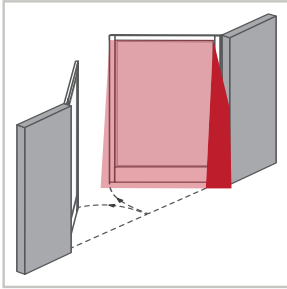





**See the chart in Appendix 1 for door height/width combinations that provide full coverage of the face of the door.**









## TROUBLESHOOTING



Determine if the problem is related to the sensor or the door controller by activating Service Mode (no safety) and then launch a door cycle. If the door cycle is completed successfully, check the sensor. If not, verify the door controller or wiring.

 The RED or GREEN LED is ON sporadically or permanently and the door does not react as expected.	Bad teach-in	Launch a new teach-in (closed door).
 The sensor does not react at power-on.	Unwanted detections (due to environment or external conditions)	Make sure the flexible cable does not cause detections. Verify if the laser window is dirty and clean it carefully with a damp and clean microfibre cloth if necessary (attention: the surface of the laser window is delicate)
 The sensor does not react when powered.	Inverted power supply	Switch DIP 2 to off (critical environment).
 It is not possible to adjust a setting by remote control.	Faulty cable	Check wiring (red +, black -).
	Faulty sensor	Replace cable
	Test error	Replace sensor
	The service mode is activated.	Check wiring between purple wires.
	Wrong DIP switch position.	Press the push button for at least 3 seconds to exit the service mode.
		Adjust the required DIP switches to ON.

## TROUBLESHOOTING (cont.)

	The RED LED flashes quickly when unlocked.	The sensor is protected by a password.	Enter the right password. If you forgot the code, cut and restore the power supply to access the sensor without entering a password within 1 minute.
	The ORANGE LED is on permanently.	The sensor encounters a memory problem.	Replace sensor.
	The ORANGE LED flashes quickly.	DIP switch setting awaiting confirmation.	Confirm the DIP switch setting: long push on the push button.
	The ORANGE LED flashes 1 x every 3 seconds.	The sensor signals an internal fault.	Cut and restore power supply. If orange LED flashes again, replace sensor.
	The ORANGE LED flashes 2 x every 3 seconds.	Power supply is out of limit.	Check power supply (voltage).
		Internal temperature is too high.	Reduce the cable length or change cable. Protect the sensor from any heat source (sun, hot air...)
	The ORANGE LED flashes 3 x every 3 seconds.	Communication error between sensors	Check wiring between Primary and Secondary sensors.
			Check wiring between interface card and laser head.
	The ORANGE LED flashes 4 x every 3 seconds.	The sensor does not see its background.  Something close to the sensor is masking part of the detection field.	Using the remote control, set the background to 0 (off, deactivates background).
			Make sure the laser window is not scratched. If it is, replace sensor.
			Remove all masking elements (insects, spider web, door loop, window protection).
			Verify if the laser window is dirty and clean it carefully with a damp and clean microfiber cloth if necessary (attention: the surface of the laser window is delicate)
	The ORANGE LED flashes 5 x every 3 seconds.	Teach-in error	Switch antimasking setting to off (attention: no conformity to DIN 18650 or EN 16005).
			Check whether all teach-in requirements are fulfilled (see page 7) and launch a new teach-in (closed door).
		Permanent faulty measurements of door position.	Adjust the tilt angle of the laser curtain and launch a new teach-in (closed door).
Launch a new teach-in (closed door).			
	The ORANGE LED flashes 6 x every 3 seconds.	Sporadic faulty measurements of door position.	If orange LED flashes again, contact BEA.
			Clear field and wait until the door closes.
			If the door does not close, cut power supply and restore it once the door is fully closed.  Launch a new teach-in (closed door).

Can't find your answer? Visit [www.beainc.com](http://www.beainc.com) or scan QR code for Frequently Asked Questions!



## TECHNICAL SPECIFICATIONS

Technology:	LASER scanner, time-of-flight measurement
Detection mode:	Presence
Max. detection range:	13' (diagonal) with reflectivity of 2% (i.e. at W = 5' → max. H = 12')
Opening angle:	Door leaf safety: 90° Pinch zone safety: 16°
Angular resolution:	Door leaf safety: 1.3° Pinch zone safety: 0.2°
Typ. min. object size	
door leaf safety:	4" @ 13' (in proportion to object distance, DIP 2 = ON)
pinch zone safety:	¾" @ 13' (in proportion to object distance, DIP 2 = ON)
Emission characteristics	
IR LASER:	Wavelength 905 nm; max. output pulse power 25 W; Class 1
Supply voltage:	12 – 24 VDC ±15%
Power consumption:	≤ 2 W
Response time:	Door leaf safety: max. 50 ms / Pinch zone safety: max. 90 ms
Test input:	30 VDC (max. switching voltage) low < 1 V      high > 10 V (voltage threshold)
Output:	2 electronic relays (galvanic isolation - polarity free)
max. switching voltage:	42 VAC/VDC
max. switching current:	100 mA
LED signals:	Red = swing side detection Green = approach side detection Yellow = error
Dimensions:	5 ½" (L) × 3 ⅓" (H) × 1" (D) (mounting bracket + ¼")
Material/Color:	PC/ASA / Black - Aluminium - White
Tilt angles:	2° – 10° (without mounting bracket)
Protection degree:	IP54 (EN 60529)
Temperature range:	-22 – 140 °F (if powered)
Humidity:	0 – 95% non-condensing
Vibrations:	< 2 G
Min. door leaf speed:	2°/sec
Compliance:	ISO 13849-1 PL "d"/ CAT2; IEC 60825-1; IEC 60950-1; IEC 61000-6-2; IEC 61000-6-3; IEC 62061 SIL 2; UL10 (black material only) – file # R39071

*Specifications are subject to change without prior notice.  
All values measured in specific conditions.*

# APPENDIX 1: DOOR HEIGHT/WIDTH COMBINATIONS

DOOR WIDTH (feet)

	1	1.5	2	2.5	3	3.5	4	4.5	5	5.5	6	6.5	7	7.5	8	8.5	9	9.5	10	10.5	11	11.5	12	12.5	13
1	1.41	1.80	2.24	2.69	3.16	3.64	4.12	4.61	5.10	5.59	6.08	6.58	7.07	7.57	8.06	8.56	9.06	9.55	10.05	10.55	11.05	11.54	12.04	12.54	13.04
1.5	1.80	2.12	2.50	2.92	3.35	3.81	4.27	4.74	5.22	5.70	6.18	6.67	7.16	7.65	8.14	8.63	9.12	9.62	10.11	10.61	11.10	11.60	12.09	12.59	13.09
2	2.24	2.50	2.83	3.20	3.61	4.03	4.47	4.92	5.39	5.85	6.32	6.80	7.28	7.76	8.25	8.73	9.22	9.71	10.20	10.69	11.18	11.67	12.17	12.66	13.15
2.5	2.69	2.92	3.20	3.54	3.91	4.30	4.72	5.15	5.59	6.04	6.50	6.96	7.43	7.91	8.38	8.86	9.34	9.82	10.31	10.79	11.28	11.77	12.26	12.75	13.24
3	3.16	3.35	3.61	3.91	4.24	4.61	5.00	5.41	5.83	6.26	6.71	7.16	7.62	8.08	8.54	9.01	9.49	9.96	10.44	10.92	11.40	11.88	12.37	12.85	13.34
3.5	3.64	3.81	4.03	4.30	4.61	4.95	5.32	5.70	6.10	6.52	6.95	7.38	7.83	8.28	8.73	9.19	9.66	10.12	10.59	11.07	11.54	12.02	12.50	12.98	13.46
4	4.12	4.27	4.47	4.72	5.00	5.32	5.66	6.02	6.40	6.80	7.21	7.63	8.06	8.50	8.94	9.39	9.85	10.31	10.77	11.24	11.70	12.18	12.65	13.12	13.60
4.5	4.61	4.74	4.92	5.15	5.41	5.70	6.02	6.36	6.73	7.11	7.50	7.91	8.32	8.75	9.18	9.62	10.06	10.51	10.97	11.42	11.88	12.35	12.82	13.29	13.76
5	5.10	5.22	5.39	5.59	5.83	6.10	6.40	6.73	7.07	7.43	7.81	8.20	8.60	9.01	9.43	9.86	10.30	10.74	11.18	11.63	12.08	12.54	13.00	13.46	13.93
5.5	5.59	5.70	5.85	6.04	6.26	6.52	6.80	7.11	7.43	7.78	8.14	8.51	8.90	9.30	9.71	10.12	10.55	10.98	11.41	11.85	12.30	12.75	13.20	13.66	14.12
6	6.08	6.18	6.32	6.50	6.71	6.95	7.21	7.50	7.81	8.14	8.49	8.85	9.22	9.60	10.00	10.40	10.82	11.24	11.66	12.09	12.53	12.97	13.42	13.87	14.32
6.5	6.58	6.67	6.80	6.96	7.16	7.38	7.63	7.91	8.20	8.51	8.85	9.19	9.55	9.92	10.31	10.70	11.10	11.51	11.93	12.35	12.78	13.21	13.65	14.09	14.53
7	7.07	7.16	7.28	7.43	7.62	7.83	8.06	8.32	8.60	8.90	9.22	9.55	9.90	10.26	10.63	11.01	11.40	11.80	12.21	12.62	13.04	13.46	13.89	14.33	14.76
7.5	7.57	7.65	7.76	7.91	8.08	8.28	8.50	8.75	9.01	9.30	9.60	9.92	10.26	10.61	10.97	11.34	11.72	12.10	12.50	12.90	13.31	13.73	14.15	14.58	15.01
8	8.06	8.14	8.25	8.38	8.54	8.73	8.94	9.18	9.43	9.71	10.00	10.31	10.63	10.97	11.31	11.67	12.04	12.42	12.81	13.20	13.60	14.01	14.42	14.84	15.26
8.5	8.56	8.63	8.73	8.86	9.01	9.19	9.39	9.62	9.86	10.12	10.40	10.70	11.01	11.34	11.67	12.02	12.38	12.75	13.12	13.51	13.90	14.30	14.71	15.12	15.53
9	9.06	9.12	9.22	9.34	9.49	9.66	9.85	10.06	10.30	10.55	10.82	11.10	11.40	11.72	12.04	12.38	12.73	13.09	13.45	13.83	14.21	14.60	15.00	15.40	15.81
9.5	9.55	9.62	9.71	9.82	9.96	10.12	10.31	10.51	10.74	10.98	11.24	11.51	11.80	12.10	12.42	12.75	13.09	13.44	13.79	14.16	14.53	14.92	15.31	15.70	16.10
10	10.05	10.11	10.20	10.31	10.44	10.59	10.77	10.97	11.18	11.41	11.66	11.93	12.21	12.50	12.81	13.12	13.45	13.79	14.14	14.50	14.87	15.24	15.62	16.01	16.40
10.5	10.55	10.61	10.69	10.79	10.92	11.07	11.24	11.42	11.63	11.85	12.09	12.35	12.62	12.90	13.20	13.51	13.83	14.16	14.50	14.85	15.21	15.57	15.95	16.32	16.71
11	11.05	11.10	11.18	11.28	11.40	11.54	11.70	11.88	12.08	12.30	12.53	12.78	13.04	13.31	13.60	13.90	14.21	14.53	14.87	15.21	15.56	15.91	16.28	16.65	17.03
11.5	11.54	11.60	11.67	11.77	11.88	12.02	12.18	12.35	12.54	12.75	12.97	13.21	13.46	13.73	14.01	14.30	14.60	14.92	15.24	15.57	15.91	16.26	16.62	16.99	17.36
12	12.04	12.09	12.17	12.26	12.37	12.50	12.65	12.82	13.00	13.20	13.42	13.65	13.89	14.15	14.42	14.71	15.00	15.31	15.62	15.95	16.28	16.62	16.97	17.33	17.69
12.5	12.54	12.59	12.66	12.75	12.85	12.98	13.12	13.29	13.46	13.66	13.87	14.09	14.33	14.58	14.84	15.12	15.40	15.70	16.01	16.32	16.65	16.99	17.33	17.68	18.03
13	13.04	13.09	13.15	13.24	13.34	13.46	13.60	13.76	13.93	14.12	14.32	14.53	14.76	15.01	15.26	15.53	15.81	16.10	16.40	16.71	17.03	17.36	17.69	18.03	18.38

DOOR HEIGHT (feet)

Any combination marked in red DOES NOT cover the full face of the door, and is, therefore, not recommended.



### BEA, INC. INSTALLATION/SERVICE COMPLIANCE EXPECTATIONS

BEA, Inc., the sensor manufacturer, cannot be held responsible for incorrect installations or incorrect adjustments of the sensor/device; therefore, BEA, Inc. does not guarantee any use of the sensor/device outside of its intended purpose.

BEA, Inc. strongly recommends that installation and service technicians be AAADM-certified for pedestrian doors, IDA-certified for doors/gates, and factory-trained for the type of door/gate system.

Installers and service personnel are responsible for executing a risk assessment following each installation/service performed, ensuring that the sensor/device system performance is compliant with local, national, and international regulations, codes, and standards.

Once installation or service work is complete, a safety inspection of the door/gate shall be performed per the door/gate manufacturer's recommendations and/or per AAADM/ANSI/DASMA guidelines (where applicable) for best industry practices. Safety inspections must be performed during each service call – examples of these safety inspections can be found on an AAADM safety information label (e.g. ANSI/DASMA 102, ANSI/DASMA 107, UL294, UL325, and International Building Code).

Verify that all appropriate industry signage, warning labels, and placards are in place.



A Halma company

Tech Support & Customer Service: 1-800-523-2462

General Tech Questions: techservices-us@BEAsensors.com | Tech Docs: www.BEAsensors.com

See Application Note 78.6023