

IS40 / IS40 XL

Motion and presense sensor for
automatic industrial doors

(US version)

IS40: for normal to high mounting 8 – 16 ft
IS40 XL: for low mounting 6.5 – 11.5 ft



Visit website for
available languages of
this document.

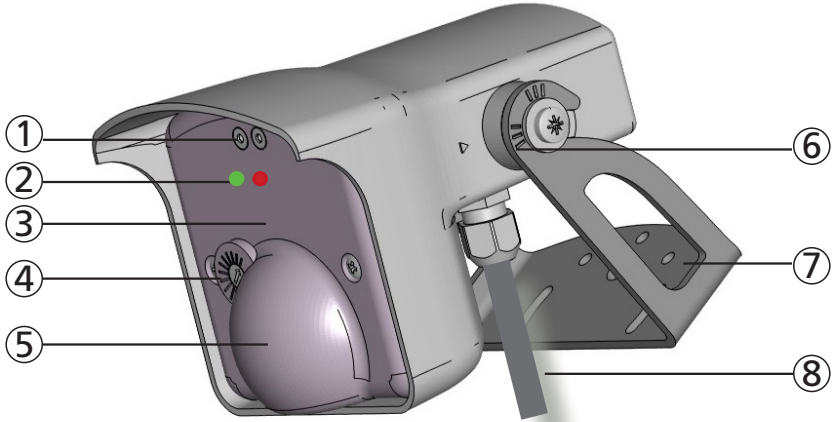

1. push buttons
2. LEDs
3. infrared detection (AIR)
4. radar angle
5. radar detection
6. sensor angle indicator
7. bracket
8. cable

TECHNICAL SPECIFICATIONS

| | |
|------------------------------|--|
| Supply voltage: | 12 – 24 VAC +10%, 12 – 24 VDC +10% / -3% |
| Power consumption: | < 3.5 W |
| Mains frequency: | 50 – 60 Hz |
| Output: | 2 relays (free of potential change-over contact) |
| max. contact voltage: | 42 VAC/VDC |
| max. contact current: | 1 A (resistive) |
| max. switching power: | 30 W (DC) / 48 VA (AC) |
| Mounting height*: | IS40: 8 – 16' IS40 XL: 6.5 – 11.5' |
| Temperature range: | -22 – 140 °F |
| Humidity: | 0 – 95% non-condensing |
| Degree of protection: | IP65 / NEMA4 |
| Dimensions: | 3.75" (W) × 4" (H) × 5" (D) |
| Materials: | ABS and polycarbonate |
| Weight: | 14 oz |
| Cable length: | 32' |
| Norm conformity: | R&TTE 1999/5/EC; EMC 2004/108/EC, R&TTE: 1999/5/EC |



| | | |
|---|---|--|
| Technology: | microwave doppler radar | active infrared (AIR) |
| Transmitter frequency/ wavelength: | 24.150 GHz | 875 nm |
| Output holdtime: | 0.5 – 9 s | 0.5 s |
| Transmitter power density: | < 5 mW/cm ² | < 250 mW/cm ² |
| Detection mode: | motion | presence |
| Detection field: | IS40: 13' × 16.5' IS40 XL: 13' × 6.5' <i>measured at 30°, field size 9, mounting height 16' × 11.5'</i> | IS40: 10' × 10' IS40 XL: 7.5' × 7.5' <i>zone detected with SPOTFINDER; therefore, slightly larger than the effective detection field</i> |
| Min. detection speed: | 2 in/s | 0 in/s to activate detection |
| Reaction time: | 100 ms | 250 ms |
| Tilt angle: | -8 – 22° (relative to sensor front face) | 15 – 45° |

Specifications are subject to change without prior notice.
All values measured in specific conditions.

PRECAUTIONS



CAUTION

- ❑ This device is NOT intended for use as a safety sensor.
- ❑ Shut off all power going to header before attempting any wiring procedures.
- ❑ Maintain a clean and safe environment when working in public areas.
- ❑ Constantly be aware of pedestrian/vehicle traffic around the area.
- ❑ Always stop pedestrian/vehicle traffic through the doorway when performing tests that may result in unexpected reactions by the door.
- ❑ *ESD (electrostatic discharge)*: Circuit boards are vulnerable to damage by electrostatic discharge. Before handling any board, ensure you dissipate your body's ESD charge.
- ❑ Always check placement of all wiring before powering up to ensure that moving door parts will not catch any wires and cause damage to equipment.
- ❑ Ensure compliance with all applicable safety standards upon completion of installation.
- ❑ DO NOT attempt any internal repair of the components. All repairs and/or component replacements must be performed by BEA, Inc. Unauthorized disassembly or repair:
 1. May jeopardize personal safety and may expose one to the risk of electrical shock.
 2. May adversely affect the safe and reliable performance of the product resulting in a voided warranty.



Only trained and qualified personnel may install and setup the sensor.



Only trained and qualified personnel are recommended to install and set up the sensor.



Always test the proper operation of the installation before leaving the premises.

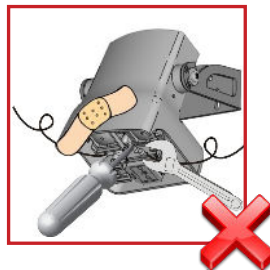

The warranty is void if unauthorized repairs are made or attempted by unauthorized personnel.

LED INDICATIONS AND SYMBOLS



Activation/Pulse detection

green



LED flashes

Value indication for manual setup

green



Setup

red/green



Presence detection

red



LED flashes

Parameter indication for manual setup

red



LED flashes quickly

red



FACTORY VALUES

USEFUL DIMENSIONS

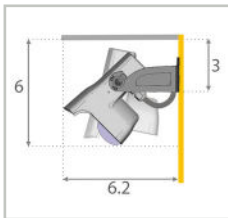

Wall mounting

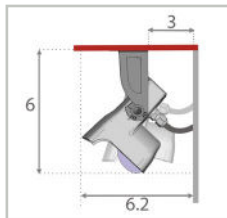

Ceiling mounting

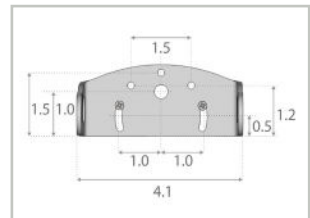

Bracket dimensions

MOUNTING TIPS



Do not cover the sensor.



Avoid extreme vibrations.



Avoid proximity to neon lamps or moving objects.

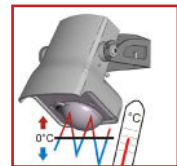

Avoid exposing the sensor to sudden temperature changes.

1 MOUNTING

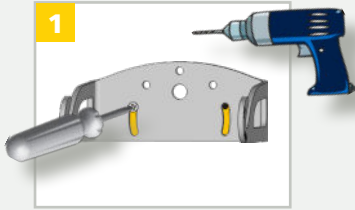

Remove the bracket from the sensor.
Drill 2 holes accordingly.
Secure the bracket.

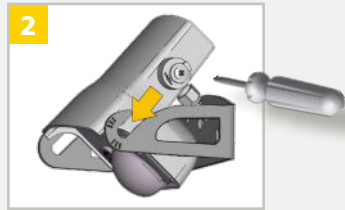

Position the sensor on the bracket and tighten the screws.

2 WIRING

RED — POWER SUPPLY
BLACK — 12 – 24 VAC/VDC

WHITE — COM
GREEN — NO
YELLOW — NC

WHITE/BLACK — COM
GREEN/BLACK — NO
YELLOW/BLACK — NC

RADAR OUTPUT
Motion signal

AIR OUTPUT
Presence signal

RELAY CONFIGURATION

| | Motion Relay | Presence Relay |
|---|--------------|----------------|
| 1 | Active | Passive |
| 2 | Passive | Active |
| 3 | Passive | Passive |
| 4 | Active | Active |



| Description | Detection | No Detection |
|---------------|------------------|------------------|
| Active Relay | COM — NO ● NC | COM — NO ● NC |
| Passive Relay | COM — NO ● NC | COM — NO ● NC |

3 SENSOR ANGLE

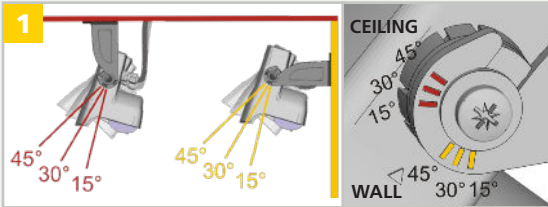

Adjust the angle of the sensor to position the detection fields.

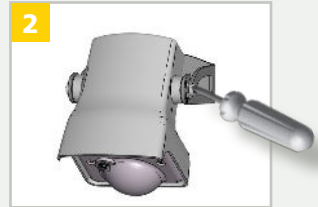

Tighten the screws firmly.

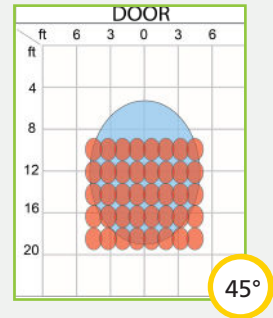
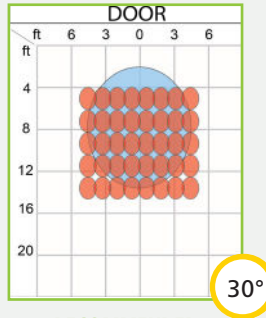
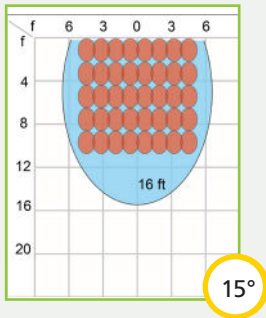

RECOMMENDED

- The graphics above are not to scale and are for illustration purposes only. These graphics represent approximate detection fields when mounted at 16 feet high. AIR-Infrared field = emitting spots detectable by using the SPOTFINDER. The actual detection field is slightly smaller and is influenced by external factors.
- It's important to adjust the sensor angle to position the detection fields correctly for your application. Utilizing a mounting bracket, sensor location, and reveal will dictate the sensor angle for your application.

HOW TO USE THE REMOTE CONTROL



After unlocking, the red LED flashes and the sensor can be adjusted by remote control.



If the red LED flashes quickly after unlocking, enter an access code from 1 to 4 digits.

If you do not know the access code, **cut and restore the power supply** and within the first minute, you can access the sensor without introducing any access code.



ADJUSTING ONE OR MORE PARAMETERS



CHECKING A VALUE



The number of flashes indicates the value of the chosen parameter.

RESTORING TO FACTORY VALUES



SAVING AN ACCESS CODE

access code recommended for sensors installed close to each other



DELETING AN ACCESS CODE

If you do not know the access code, **cycle the power** and within the first minute, you can access the sensor without entering an access code.

Additionally within the first minute, you may delete an unknown access using the remote control (see steps below).



DELETING AN UNKNOWN ACCESS CODE



4 RADAR FIELD AND AIR PATTERN

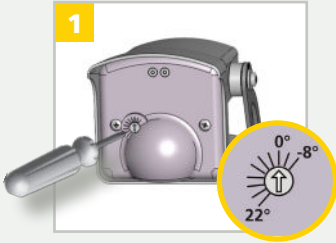

Turn this screw to adjust the radar field angle from -8° to 22° .



Adjust the field size.
 $S = 2, L = 7$.

p. 6

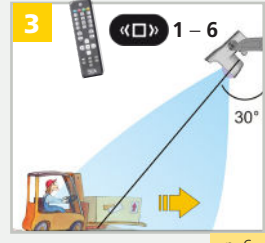

Choose the appropriate detection filter for your application.

p. 6

The total angle is the sum of the sensor angle and the radar field angle.

$$\text{SENSOR ANGLE} + \text{RADAR FIELD ANGLE} = \text{TOTAL ANGLE}$$

All detection field dimensions were measured in optimal conditions with a sensitivity value of 7.

IS40

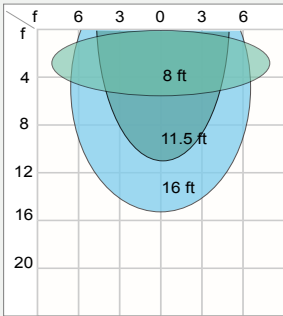

Sensor angle: 30°
 Radar field angle: -8°
 Total angle: 22°

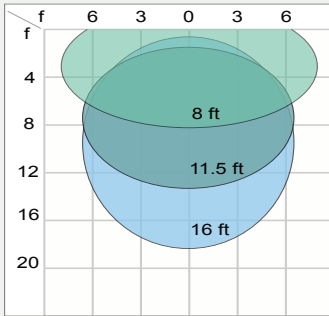
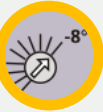

Sensor angle: 30°
 Radar field angle: 0°
 Total angle: 30°

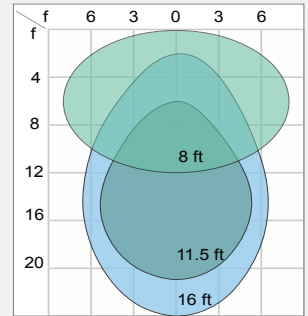
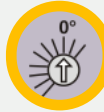

Sensor angle: 30°
 Radar field angle: $+11^{\circ}$
 Total angle: 41°



IS40 XL

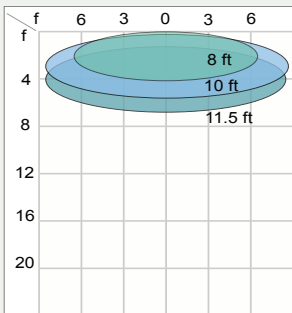

Sensor angle: 30°
 Radar field angle: -8°
 Total angle: 22°

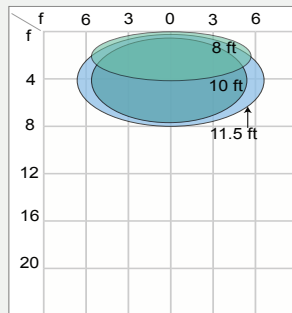
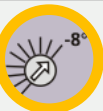

Sensor angle: 30°
 Radar field angle: 0°
 Total angle: 30°

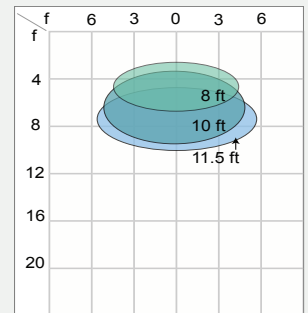
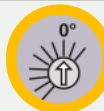

Sensor angle: 30°
 Radar field angle: $+11^{\circ}$
 Total angle: 41°



POSSIBLE REMOTE CONTROL SETTINGS (motion sensing)



FIELD SIZE
(SENSITIVITY)



XXS XS S > > > > L XL XXL

HOLD-OPEN TIME



0.5 s 1 s 2 s 3 s 4 s 5 s 6 s 7 s 8 s 9 s

DETECTION MODE



bi uni uni AWAY

bi = two-way detection
uni = one-way detection towards sensor
uni AWAY = one-way detection away from sensor

DETECTION FILTER
(REJECTION MODE)



1 2 3 4 5 6

Detection of ALL TARGETS
(pedestrians, vehicles and parallel traffic are detected)

- 1 Detection of all Targets in Motion
- 2 Detection of all Targets in Motion + Interference Immunity

Detection only of VEHICLES MOVING TOWARDS THE SENSOR
(pedestrians and parallel traffic are not detected + immunity filter)

- 3 Low 'Pedestrian/Parallel traffic' Rejection + Interference Immunity
- 4 Medium 'Pedestrian/Parallel traffic' Rejection + Interference Immunity
- 5 High 'Pedestrian/Parallel traffic' Rejection + Interference Immunity
- 6 Extra High 'Pedestrian/Parallel traffic' Rejection + Interference Immunity

| OUTPUT CONFIGURATION | PRESENCE RELAY | IS40 / IS40XL | LED | |
|--|---|---------------|--|-------|
| | 0 – 6: ALL MODES | | Activates when object is in presence zone. | red |
| F1 DOOR EXAMPLE First Line Last Line | ACTIVATION RELAY | IS40 / IS40XL | LED | |
| | 0: STANDARD MODE | | Activates when motion detected. | green |
| | 1: PULSE ON ENTRY | | Activates if object motion is detected and then object enters presence zone. | |
| | 2: PULSE ON EXIT | | Activates if object motion is detected and then object exits presence zone. | |
| | 3: PULSE ON ENTRY FIRST / LAST LINE <i>see example (left)</i> | | Activates if object motion is detected and then object enters presence zone (first or last line). | |
| | 4: PULSE ON EXIT FIRST / LAST LINE <i>see example (left)</i> | | Activates if object motion is detected and then object exits presence zone (first or last line). | |
| | 5: REMAINS ACTIVE UNTIL PRESENCE ZONE IS CLEARED (regardless of motion) | | Activates when motion is detected and remains active until the presence zone is cleared. | |
| | 6: REMAINS ACTIVE UNTIL PRESENCE ZONE IS CLEARED (regardless of motion) | | Activates when motion is detected and AIR is detected and remains active until the presence zone is cleared. | |

AIR PATTERN SIZE AT 15° SENSOR ANGLE

| Mounting Height | Width* | Depth* |
|-----------------|--------|--------|
| 8 ft | 5 ft | 5 ft |
| 10 ft | 7 ft | 7 ft |
| 11.5 ft | 7.5 ft | 7.5 ft |
| 13 ft | 8.5 ft | 8.5 ft |
| 16 ft | 10 ft | 10 ft |

mounting height increases → AIR pattern increases

| MAXIMUM Mounting Height | |
|-------------------------|---------|
| IS40XL | 11.5 ft |
| IS40 | 16 ft |

* Dimensions are approximate.

5 SETUP

Launch a setup to make a reference picture.

Step out of the detection field and do not leave any tools inside the detection field.

Upon power-up, the sensor launches a short setup.



IMPORTANT: Perform a functional test for proper operation before leaving the site.

POSSIBLE REMOTE CONTROL SETTINGS (*presence sensing*)



FREQUENCY



| | | | | | | | | | |
|----------------------|--------------------------------|--------------------------------|----------------------|----------------------|----------------------|----------------------|----------------------|----------------------|----------------------|
| <input type="text"/> | <input type="text" value="A"/> | <input type="text" value="B"/> | <input type="text"/> | <input type="text"/> | <input type="text"/> | <input type="text"/> | <input type="text"/> | <input type="text"/> | <input type="text"/> |
|----------------------|--------------------------------|--------------------------------|----------------------|----------------------|----------------------|----------------------|----------------------|----------------------|----------------------|

MAX. PRESENCE DETECTION TIME



| | | | | | | | | | |
|-------------------------------------|------------------------------------|------------------------------------|------------------------------------|-------------------------------------|-------------------------------------|-----------------------------------|-------------------------------------|-----------------------------------|--|
| <input type="text" value="30 sec"/> | <input type="text" value="1 min"/> | <input type="text" value="2 min"/> | <input type="text" value="5 min"/> | <input type="text" value="10 min"/> | <input type="text" value="20 min"/> | <input type="text" value="1 hr"/> | <input type="text" value="1.5 hr"/> | <input type="text" value="2 hr"/> | <input type="text" value="no learn*"/> |
|-------------------------------------|------------------------------------|------------------------------------|------------------------------------|-------------------------------------|-------------------------------------|-----------------------------------|-------------------------------------|-----------------------------------|--|

* NOT GUARANTEED

AIR-CURTAIN IMMUNITY



| | | | | | | | | | |
|----------------------|----------------------------------|-------------------------------------|-----------------------------------|----------------------|----------------------|----------------------|----------------------|----------------------|----------------------|
| <input type="text"/> | <input type="text" value="low"/> | <input type="text" value="normal"/> | <input type="text" value="high"/> | <input type="text"/> | <input type="text"/> | <input type="text"/> | <input type="text"/> | <input type="text"/> | <input type="text"/> |
|----------------------|----------------------------------|-------------------------------------|-----------------------------------|----------------------|----------------------|----------------------|----------------------|----------------------|----------------------|

TARGET SIZE



| | | | | | | | | | |
|----------------------|----------------------------------|----------------------------------|----------------------------------|----------------------------------|----------------------------------|----------------------------------|----------------------------------|----------------------|----------------------|
| <input type="text"/> | <input type="text" value="2x2"/> | <input type="text" value="3x2"/> | <input type="text" value="4x2"/> | <input type="text" value="5x2"/> | <input type="text" value="6x2"/> | <input type="text" value="7x2"/> | <input type="text" value="8x2"/> | <input type="text"/> | <input type="text"/> |
|----------------------|----------------------------------|----------------------------------|----------------------------------|----------------------------------|----------------------------------|----------------------------------|----------------------------------|----------------------|----------------------|

AIR PATTERN SIZE



| | | | | | | | | | |
|----------------------|------------------------------------|------------------------------------|------------------------------------|------------------------------------|------------------------------------|------------------------------------|------------------------------------|------------------------------------|------------------------------------|
| <input type="text"/> | <input type="text" value="10x10"/> | <input type="text" value="10x15"/> | <input type="text" value="10x20"/> | <input type="text" value="10x25"/> | <input type="text" value="10x30"/> | <input type="text" value="10x35"/> | <input type="text" value="10x40"/> | <input type="text" value="10x45"/> | <input type="text" value="10x50"/> |
|----------------------|------------------------------------|------------------------------------|------------------------------------|------------------------------------|------------------------------------|------------------------------------|------------------------------------|------------------------------------|------------------------------------|

The target position within the "AIR" Field is random.

AIR PATTERN SIZE



AVAILABLE TARGET SIZE

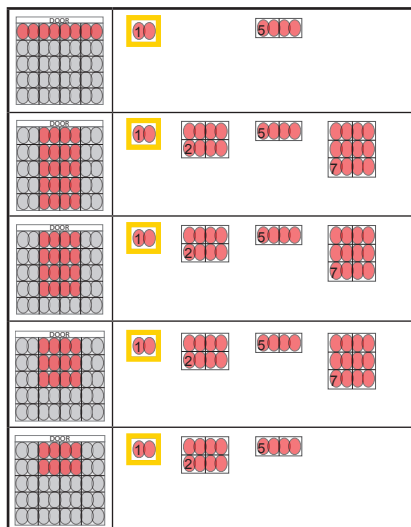
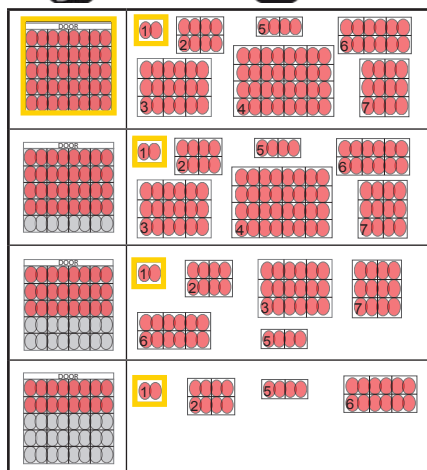











NOTE: TARGET SIZE MUST BE ABLE TO FIT INSIDE THE CHOSEN AIR PATTERN SIZE.

IMPORTANT: Always finish an adjustment session by launching a setup (*see step 5*) and test the proper operation of the installation before leaving the premises.



TROUBLESHOOTING

| | | | |
|--|---|---|--|
|  | The door never closes and the red LED is on. | Objects are present in the AIR detection area. | Move objects or reduce automatic learn time. Wait for learn time to expire and/or launch a setup. |
|  | The door remains closed and the LED is OFF. | The sensor power is off. | Check the wiring and the power supply. |
|  | The infrared sensor does not react. | The infrared power emission is too low with respect to the mounting height. | Lower the mounting height. Step out of the detection field and launch a new setup. Possible target size too large. |
|  | The door opens for no apparent reason. | The sensor detects raindrops or vibrations. | Make sure the detection mode is unidirectional. Increase the detection filter value. |
| | | The sensor is not installed properly. | Secure the sensor. |
| | | In highly reflective environments, the sensor detects objects outside of its detection field. | Change the antenna angle. Decrease the field size. Increase the detection filter value. |
|  | The vehicle detection filter is used, but pedestrians are still detected. | The chosen value is not optimal for the application. | Increase the detection filter value. Change the sensor angle. Increase the mounting height. |
|  | The door opens and closes constantly. | The sensor is disturbed by the door motion or vibrations caused by the door motion. | Make sure the sensor is anchored properly. Make sure the detection mode is unidirectional. Change the sensor angle and/or radar angle. Increase the detection filter value. Reduce the field size. |
|  | Sporadic presence detections for no reason. | The presence detection is disturbed by rain or external environment. | Set the AIRcurtain immunity to value 3. Refer to page 7. |
| | | The sensor is not installed properly. | Secure the sensor. |
|  | The red LED is permanently ON after a setup. | The sensor has failed the AIR setup. | Step out of the detection field and launch a new setup. |
|  | The setup lasts more than 30 seconds. | The setup is disturbed. | Make sure the detection field is clear and launch a new setup. |
| | | Another sensor is causing interferences. | Refer to page 7 and select a different frequency for each sensor. |
|  | The sensor does not unlock and the red LED flashes quickly. | The sensor needs an access code to unlock. | Enter the correct access code. If you do not know the access code, refer to page 4 and delete an unknown code. |
| | | The remote control batteries are weak or improperly installed. | Check the batteries and change them if necessary. |
| | | The remote control is poorly aimed. | Aim the remote control towards the sensor. |
| | The sensor is not powered. | | Check the power supply of the sensor. |

Can't find your answer? Visit www.beainc.com or scan QR code for Frequently Asked Questions!



ACCESSORIES



10REMOTE



10SPOTFINDER



10BR3X

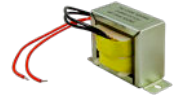

1024VAC



10INDBRACKET



10MINIBRACKET



SINGLE LED
TRAFFIC LIGHT



DUAL LED
TRAFFIC LIGHT



COLUMN LIGHT



MODULAR
COLUMN LIGHT

BEA, INC. INSTALLATION/SERVICE COMPLIANCE EXPECTATIONS

BEA, Inc., the sensor manufacturer, cannot be held responsible for incorrect installations or incorrect adjustments of the sensor/device; therefore, BEA, Inc. does not guarantee any use of the sensor/device outside of its intended purpose.

BEA, Inc. strongly recommends that installation and service technicians be AAADM-certified for pedestrian doors, IDA-certified for doors/gates, and factory-trained for the type of door/gate system.

Installers and service personnel are responsible for executing a risk assessment following each installation/service performed, ensuring that the sensor/device system performance is compliant with local, national, and international regulations, codes, and standards.

Once installation or service work is complete, a safety inspection of the door/gate shall be performed per the door/gate manufacturer's recommendations and/or per AAADM/ANSI/DASMA guidelines (where applicable) for best industry practices. Safety inspections must be performed during each service call – examples of these safety inspections can be found on an AAADM safety information label (e.g. ANSI/DASMA 102, ANSI/DASMA 107, UL294, UL325, and International Building Code).

Verify that all appropriate industry signage, warning labels, and placards are in place.



Tech Support & Customer Service: 1-800-523-2462
General Tech Questions: techservices-us@BEAsensors.com | Tech Docs: www.BEAsensors.com