

SEE OTHER SIDE FOR JAMB

KEYSWITCH (SINGLE-GANG)

Momentary / ON-OFF SPDT keyswitch
(10KEYSWITCHMOM / 10KEYSWITCHONF)



Visit website for available languages of this document.

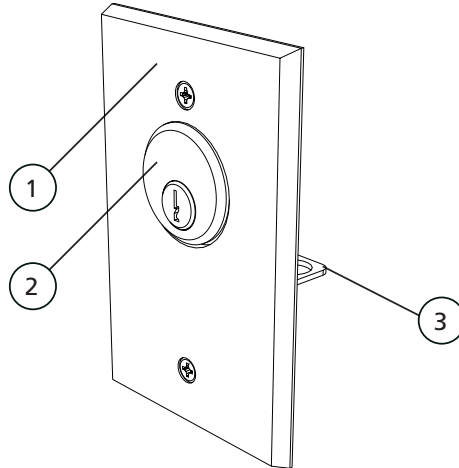

- 1. Face plate
- 2. Mortise cylinder¹
- 3. Switch²
6 A @ 125 VAC
3 A @ 250 VAC

NOTES:

- 1. Sold separately.
- 2. If two are required for the application, the second switch must be purchased separately.

MOUNTING

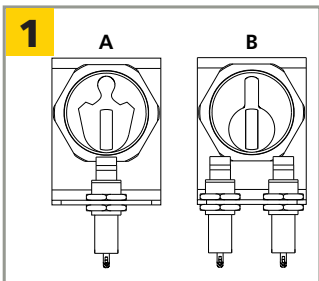

Select cam shape for keyswitches.
Mortise cylinder and second switch sold separately.

- A:**
Corbin Russwin® #ML2200
Schlage® #B520-233
(or equiv.)
- B:**
Schlage® #B520-256
Yale® #2160
Arrow® #004
Sargent® #13-0660
(or equiv.)

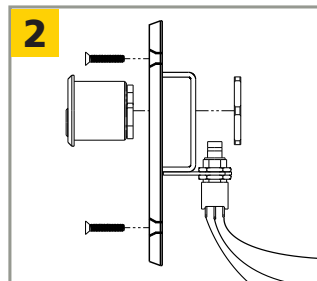

Adjust switch height on bracket until the cam triggers positively when rotated.

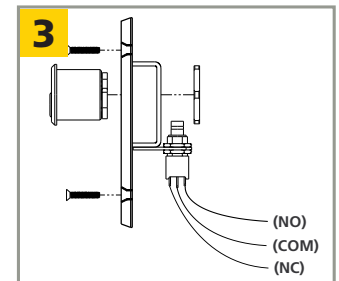

Wire accordingly.

10KEYSWITCHMOM	10KEYSWITCHONF
N.O. white	N.O. green
COM black	COM black
N.C. red	N.C. red

PRECAUTIONS



- ❑ Shut off all power going to header before attempting any wiring procedures.
- ❑ Maintain a clean and safe environment when working in public areas.
- ❑ Constantly be aware of pedestrian traffic around the door area.
- ❑ Always stop pedestrian traffic through the doorway when performing tests that may result in unexpected reactions by the door.
- ❑ **ESD (electrostatic discharge):** Circuit boards are vulnerable to damage by electrostatic discharge. Before handling any board, ensure you dissipate your body's ESD charge.
- ❑ Always check placement of all wiring before powering up to ensure that moving door parts will not catch any wires and cause damage to equipment.
- ❑ Ensure compliance with all applicable safety standards (i.e. ANSI A156.10) upon completion of installation.
- ❑ DO NOT attempt any internal repair of the components. All repairs and/or component replacements must be performed by BEA, Inc. Unauthorized disassembly or repair:
 - 1. May jeopardize personal safety and may expose one to the risk of electrical shock.
 - 2. May adversely affect the safe and reliable performance of the product resulting in a voided warranty.

BEA, INC. INSTALLATION/SERVICE COMPLIANCE EXPECTATIONS

BEA Inc., the sensor manufacturer, cannot be held responsible for incorrect installations or incorrect adjustments of the sensor/device; therefore, BEA Inc. does not guarantee any use of the sensor/device outside its intended purpose.

BEA Inc. strongly recommends that installation and service technicians be AAADM-certified for pedestrian doors, IDA-certified for doors/gates, and factory-trained for the type of door/gate system.

Installers and service personnel are responsible for executing a risk assessment following each installation/service performed, ensuring that the sensor/device system performance is compliant with local, national, and international regulations, codes, and standards.

Once installation or service work is complete, a safety inspection of the system shall be performed and documented per the manufacturer's recommendations or industry guidelines. Examples of compliance may apply to ANSI 156.10, ANSI 156.19, ANSI/DASMA 102, ANSI/DASMA 107, UL294, UL325, and International Building Code.



SEE OTHER SIDE FOR SINGLE-GANG



Visit website for available languages of this document.

KEYSWITCH (JAMB)

Momentary / ON-OFF SPDT keyswitch

(10JAMBSWITCHMOM / 10JAMBSWITCHONF)

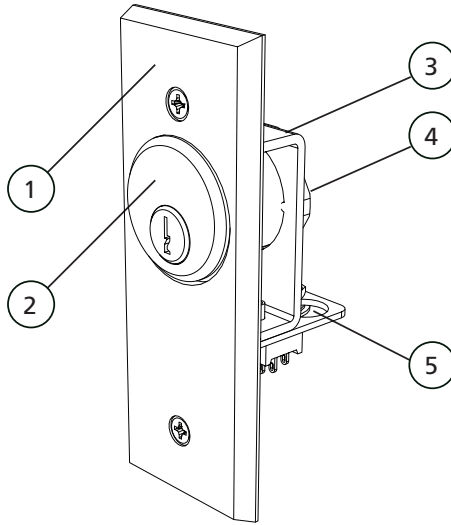

1. Face plate
2. Mortise cylinder¹
3. Switch bracket
4. Cylinder lock
5. Switch²
6 A @ 125 VAC
3 A @ 250 VAC

NOTES:

1. Sold separately.
2. If two are required for the application, the second switch must be purchased separately.

MOUNTING

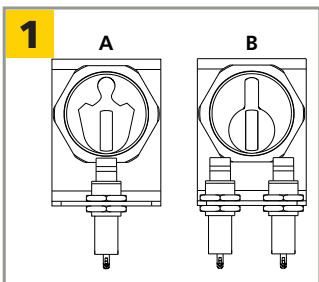

Select cam shape for keyswitches.
Mortise cylinder and second switch sold separately.

- A:**
Corbin Russwin® #ML2200
Schlage® #B520-233
(or equiv.)
- B:**
Schlage® #B520-256
Yale® #2160
Arrow® #004
Sargent® #13-0660
(or equiv.)

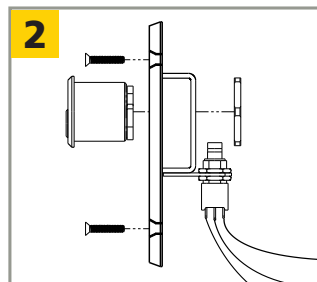

Adjust switch height on bracket until the cam triggers positively when rotated.

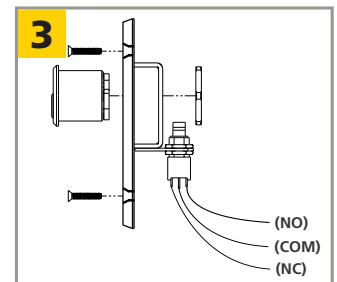

Wire accordingly.

10JAMBSWITCHMOM	10JAMBSWITCHONF
N.O. white	N.O. green
COM black	COM black
N.C. red	N.C. red

PRECAUTIONS



- ❑ Shut off all power going to header before attempting any wiring procedures.
- ❑ Maintain a clean and safe environment when working in public areas.
- ❑ Constantly be aware of pedestrian traffic around the door area.
- ❑ Always stop pedestrian traffic through the doorway when performing tests that may result in unexpected reactions by the door.
- ❑ ESD (electrostatic discharge): Circuit boards are vulnerable to damage by electrostatic discharge. Before handling any board, ensure you dissipate your body's ESD charge.
- ❑ Always check placement of all wiring before powering up to ensure that moving door parts will not catch any wires and cause damage to equipment.
- ❑ Ensure compliance with all applicable safety standards (i.e. ANSI A156.10) upon completion of installation.
- ❑ DO NOT attempt any internal repair of the components. All repairs and/or component replacements must be performed by BEA, Inc. Unauthorized disassembly or repair:
 1. May jeopardize personal safety and may expose one to the risk of electrical shock.
 2. May adversely affect the safe and reliable performance of the product resulting in a voided warranty.

BEA, INC. INSTALLATION/SERVICE COMPLIANCE EXPECTATIONS

BEA Inc., the sensor manufacturer, cannot be held responsible for incorrect installations or incorrect adjustments of the sensor/device; therefore, BEA Inc. does not guarantee any use of the sensor/device outside its intended purpose.

BEA Inc. strongly recommends that installation and service technicians be AAADM-certified for pedestrian doors, IDA-certified for doors/gates, and factory-trained for the type of door/gate system.

Installers and service personnel are responsible for executing a risk assessment following each installation/service performed, ensuring that the sensor/device system performance is compliant with local, national, and international regulations, codes, and standards.

Once installation or service work is complete, a safety inspection of the system shall be performed and documented per the manufacturer's recommendations or industry guidelines. Examples of compliance may apply to ANSI 156.10, ANSI 156.19, ANSI/DASMA 102, ANSI/DASMA 107, UL294, UL325, and International Building Code.



Tech Support & Customer Service: 1-800-523-2462 | General Tech Questions: techservices-us@BEAsensors.com | Tech Docs: www.BEAsensors.com