



MS51W

BATTERY-POWERED, TOUCHLESS ACTIVATION
WITH BUILT-IN, 900 MHZ TRANSMITTER

TECHNICAL SPECIFICATIONS

TECHNOLOGY / PERFORMANCE

| | |
|----------------------------------|--------------------------------------|
| Technology | Active infrared |
| number of IR sensors | 2 |
| Radio control type | Digital |
| Frequency | 908 – 918 MHz (frequency hopping) |
| Emitted radio power | -25 dBm (transmitter) |
| Detection range | 8" (20cm) max. |
| Battery life | 3 years (at 150 activations per day) |
| Product temperature range | -22 – 158 °F (-30 – 70 °C) |

ELECTRICAL

| | |
|--------------------------|--|
| Power supply | 3 VDC (2 AA batteries, each ~1.5 V max.) |
| Power consumption | < 0.5 mW (when idle) < 25 mW (upon RF transmission) |

PHYSICAL

Dimensions (overall)

| | |
|-------------|--------------------------------|
| single gang | 2 ¾" (W) × 4 ½" (H) × 1 ¼" (T) |
| double gang | 4 ½" (W) × 4 ½" (H) × 1 ¼" (T) |
| round | 6" (H/W) × 1 ¼" (T) |
| jamb | 1 ¾" (W) × 4 ½" (H) × 1 ¼" (T) |

| | |
|-----------------|----------------------------|
| Material | Stainless steel 304 and PC |
|-----------------|----------------------------|

| | |
|---------------|---|
| Weight | Single gang: 0.34 lb Double gang: 0.55 lb Round: 0.71 lb Jamb: 0.29 lb |
|---------------|---|

COMPLIANCE

| | |
|--------------------------|---|
| IP rating | IP65 |
| FCC certification | FCC: 2ABWS-10TD900PB IC: 4680A-10TD900PB |

*Specifications are subject to change without prior notice.
All values measured in specific conditions, using lithium batteries..*

For best performance, BEA recommends using lithium batteries.

PRECAUTIONS



CAUTION

- ❑ Shut off all power going to header before attempting any wiring procedures.
- ❑ Observe battery polarity when inserting batteries.
- ❑ Maintain a clean and safe environment when working in public areas.
- ❑ Constantly be aware of pedestrian traffic around the door area.
- ❑ Always stop pedestrian traffic through the doorway when performing tests that may result in unexpected reactions by the door.
- ❑ **ESD (electrostatic discharge):** Circuit boards are vulnerable to damage by electrostatic discharge. Before handling any board, ensure you dissipate your body's ESD charge.
- ❑ Always check placement of all wiring before powering up to ensure that moving door parts will not catch any wires and cause damage to equipment.
- ❑ Ensure compliance with all applicable safety standards (i.e. ANSI A156.10 and 156.19) upon completion of installation.
- ❑ **DO NOT** attempt any internal repair of the components. All repairs and/or component replacements must be performed by BEA, Inc. Unauthorized disassembly or repair:
 1. May jeopardize personal safety and may expose one to the risk of electrical shock.
 2. May adversely affect the safe and reliable performance of the product resulting in a voided warranty.



Only trained and qualified personnel are recommended to install and set up the sensor.

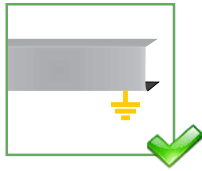

The door control system and the header cover profile must be correctly grounded.

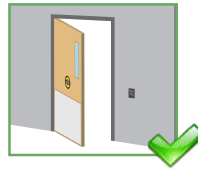

Always test the proper operation of the installation before leaving the premises.

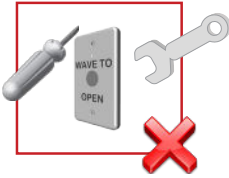

The warranty is invalid if unauthorized repairs are made or attempted by unauthorized personnel.

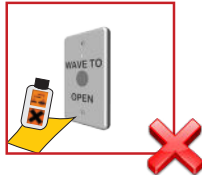

Do not use harsh cleaning agents to clean polycarbonate materials. Harsh cleaning agents (e.g. ammonia) can cause damage to these materials. BEA recommends using clean, lukewarm water and a soft, lint-free cloth to clean sensor windows and other polycarbonate surfaces on our products.

ASSEMBLY DIAGRAM

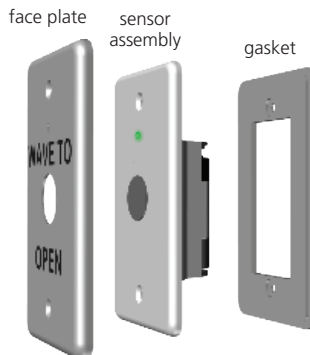

PREPARE INSTALLATION SITE

To ensure system performance, BEA recommends using only plastic electrical boxes.

1. For new installation, install the appropriate mounting box or electrical box.

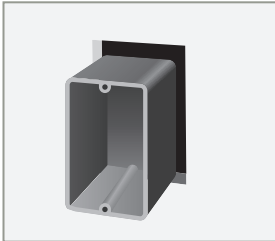

When installing jamb version, cutout dimensions are
 $1 \frac{1}{2}''$ (W) x $2 \frac{7}{8}''$ (H) x $1''$ (D min)

- For retrofitting an existing installation, remove the previous plate and transmitter.

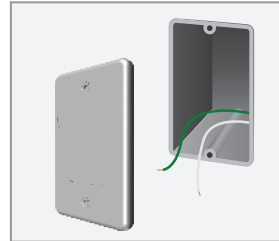

PREPARE MS51W ASSEMBLY

2. Insert 2 AA lithium batteries (provided).



Observe battery polarity when inserting batteries.



3. Make necessary DIP switch adjustments.

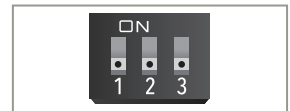

| DIP | FUNCTION | OFF (default) | ON |
|-----|--|---|--|
| 1 | Detection distance | long range (dependent on DIP 3 setting) DIP 3 ON = 5 – 6" DIP 3 OFF = 7 – 8" | short range (2 – 3") |
| 2 | LED indicator <i>(applicable to alkaline battery replacements only)</i> | battery life - multicolor ● 1x flash = full battery <i>green</i> ○ 1x flash = change batteries <i>orange</i> ● 1x flash = end of battery life <i>red</i> | battery life - unicolor ● 1x flash = full battery <i>green</i> ● 2x flash = change batteries <i>green</i> ● 3x flash = end of battery life <i>green</i> |
| 3 | Immunity | Low immunity | High immunity |

INSTALL MS51W ASSEMBLY

4. Install MS51W assembly on box. Observe the orientation of the assembly as well as each individual component.

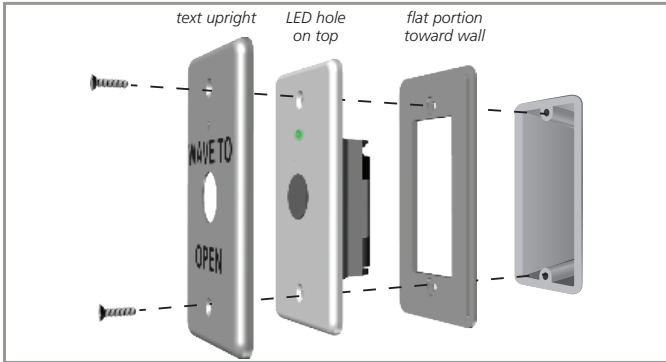

5. Secure with the provided screws (#6-32 flathead) and test functionality.



Be sure to remove the plastic film from the face plate before testing.



COMPLETE THE INSTALLATION

6. If retrofitting, ensure that the current application is equipped with a 900 MHz receiver. If not (or if new installation), install a 900 MHz receiver.
7. Pair the transmitter and receiver:
 - a. Press and release desired learn button.
The red LED on the receiver will illuminate.
 - b. Activate the MS51W twice.
The blue LED on the receiver will illuminate.

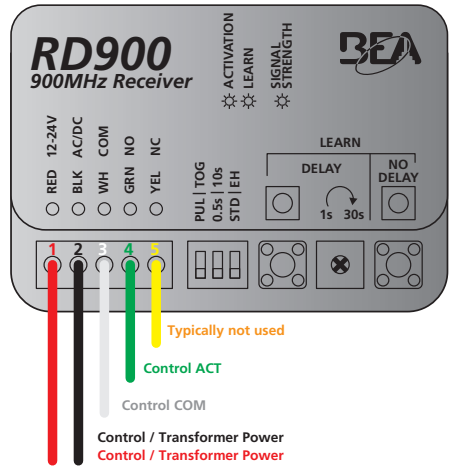
See 900 MHz Family User's Guide (75.5937) for more information.



TROUBLESHOOTING

| | | |
|---|--|--|
| MS51W does not detect when waving in front of it | Dead batteries | Check battery life by placing your hand in front of the MS51W. If there is no LED indication, replace batteries. |
| | Detection range is too short | Check DIP 1 Position (see page 4) and ensure DIP 3 is in OFF position for indoor applications. |
| | Incorrect battery orientation | Ensure batteries are installed properly with the right polarity (see label on product). |
| | Incorrect MS51W assembly, causing water to leak into the assembly | Ensure all components of the assembly have been placed in the correct orientation (see page 6, step 6). Ensure silicone is applied to the holes in mounting boxes to prevent water intrusion. |
| Door does not open when waving hand in front of the MS51W | Incorrect receiver wiring/connection | Check wiring and relay connection. |
| | Improper receiver pairing | Check receiver pairing with transmitter. |
| | Incorrect transmitter or receiver frequency | If using wireless transmitters and receivers, ensure that the operating frequencies are the same. |
| | Door safety system is holding the door closed | Clear the safety system to ensure that nothing is in detection. |
| | Transmitter interference | Ensure that a plastic junction box is used. |
|  MS51W stays in detection <ul style="list-style-type: none"> LED will remain solid LED color will depend on the DIP 2 setting | Window pollution | Check sensor window for any dirt and debris. Wipe sensor window with a non-abrasive, lint-free cloth if necessary. |
| | Cracked or damaged window | Replace the MS51W. |
|   LED flashes orange or red upon activation | Low battery indication | See page 4, step 3. orange = replace soon red = replace immediately |
| MS51W causes door activation without waving hand | Environmental conditions influencing sensor | Increase immunity settings (see page 4, step 3). |
| | | Remove moving or reflective objects in front of the MS51W. |
| | | Ensure that door movement is not causing detection. |
| | Detection range is too long. Switch to short range (see page 4, step 3). | |

FCC/IC COMPLIANCE

"This device complies with Part 15 of the FCC Rules. Operation is subject to the following two conditions: (1) this device may not cause harmful interference, and (2) this device must accept any interference received, including interference that may cause undesired operation."

Changes or modifications not expressly approved by BEA Incorporated could void the user's authority to operate the equipment.

Note: This equipment has been tested and found to comply with the limits for a Class A digital device, pursuant to part 15 of the FCC Rules. These limits are designed to provide reasonable protection against harmful interference when the equipment is operated in a commercial environment. This equipment generates, uses, and can radiate radio frequency energy and, if not installed and used in accordance with the instruction manual, may cause harmful interference to radio communications. Operation of this equipment in a residential area is likely to cause harmful interference in which case the user will be required to correct the interference at his own expense.

This device complies with Industry Canada licence-exempt RSS standard(s). Operation is subject to the following two conditions: (1) this device may not cause interference, and (2) this device must accept any interference, including interference that may cause undesired operation of the device.

Le présent appareil est conforme aux CNR d'Industrie Canada applicables aux appareils radio exempts de licence. L'exploitation est autorisée aux deux conditions suivantes : (1) l'appareil ne doit pas produire de brouillage, et (2) l'utilisateur de l'appareil doit accepter tout brouillage radioélectrique subi, même si le brouillage est susceptible d'en compromettre le fonctionnement.

| | | |
|-------------------------|---------------------|---------------------------|
| FCC ID: 2ABWS-10TD900TR | IC: 4680A-10TD900TR | Contains model: 10TD900TR |
|-------------------------|---------------------|---------------------------|

BEA, INC. INSTALLATION/SERVICE COMPLIANCE EXPECTATIONS

BEA, Inc., the sensor manufacturer, cannot be held responsible for incorrect installations or incorrect adjustments of the sensor/device; therefore, BEA, Inc. does not guarantee any use of the sensor/device outside of its intended purpose.

BEA, Inc. strongly recommends that installation and service technicians be AAADM-certified for pedestrian doors, IDA-certified for doors/gates, and factory-trained for the type of door/gate system.

Installers and service personnel are responsible for executing a risk assessment following each installation/service performed, ensuring that the sensor/device system performance is compliant with local, national, and international regulations, codes, and standards.

Once installation or service work is complete, a safety inspection of the door/gate shall be performed per the door/gate manufacturer's recommendations and/or per AAADM/ANSI/DASMA guidelines (where applicable) for best industry practices. Safety inspections must be performed during each service call – examples of these safety inspections can be found on an AAADM safety information label (e.g. ANSI/DASMA 102, ANSI/DASMA 107, UL294, UL325, and International Building Code).

Verify that all appropriate industry signage, warning labels, and placards are in place.



A Halma company

Tech Support & Customer Service: 1-800-523-2462

General Tech Questions: techservices-us@BEAsensors.com | Tech Docs: www.BEAsensors.com