

LZR-FLATSCAN W

SAFETY SENSOR FOR AUTOMATED WINDOWS

(US version)



Visit website for
available languages of
this document.

DESCRIPTION

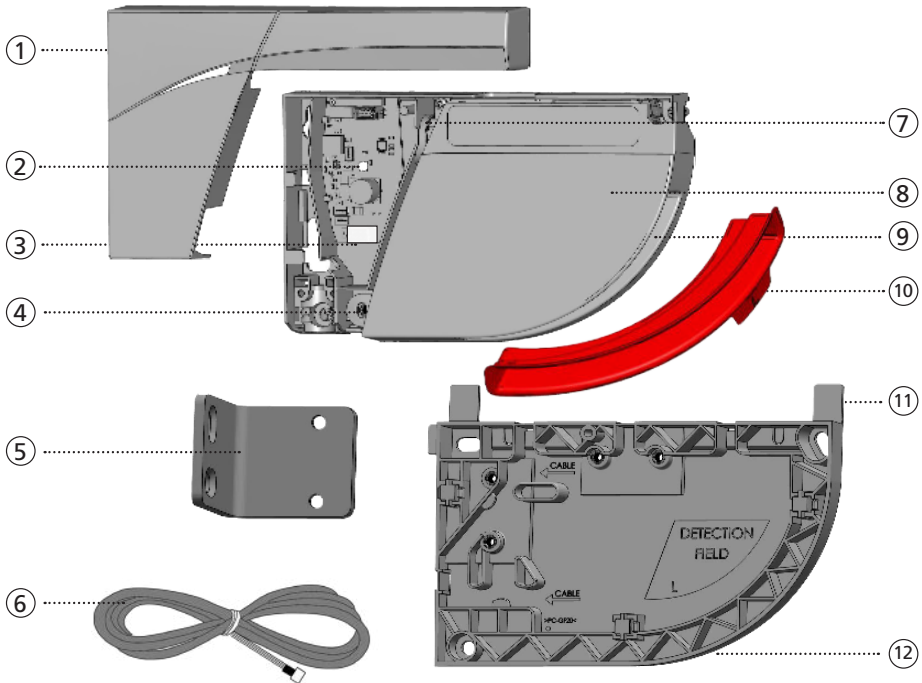

- | | | | |
|----|------------------------|-----|-----------------------------|
| 1. | cover | 7. | lock screw |
| 2. | LED | 8. | laser head |
| 3. | main connector | 9. | laser window |
| 4. | angle adjustment screw | 10. | laser window protection cap |
| 5. | mounting bracket | 11. | positioning tabs |
| 6. | power cable | 12. | mounting base |

TECHNICAL SPECIFICATIONS

Technology	LASER scanner, time-of-flight measurement, background analysis
Detection mode	Presence
Max. detection range	13' (diagonal) (e.g. @ 40' width, max. height is 16')
Number of curtains	1
Measurement points	400
Angular resolution	0.27°
Angular coverage	110 °
Min. object size	¾" (depending on the settings and the installation)
Optical characteristics	IR LASER, Class 1 wavelength: 905 nm output power: < 0.1mW
Supply voltage	12 – 24 VDC ±15% <i>The equipment must be powered by a SELV limited power source ensuring double insulation between primary voltages and the Equipment supply.</i> <i>The supply current should be limited to 1.5A.</i>
Power consumption	≤ 2 W
Typ. response time	400 ms
Peak current at power-on	0.8A (max. 20 ms @ 24 VDC)
Cable length	16.4'
Output max. switching voltage max. switching current	2 solid state relays (galvanic isolation - polarity free) 42 VAC/VDC 100 mA
Input max. contact voltage voltage threshold	1 optocoupler (galvanic isolated - polarity free) 30 V DC (over-voltage protected) Log. H: >8 VDC Log. L: <3 VDC
LED signals	1 tri-colored LED: detection/output status
Dimensions	5 ⅜" (L) × 3 ⅛" (H) × 1 ⅓" (D) (mounting base adds ½")
Material / Color	PC, ASA / black
Tilt angles	-2 – 6° (with mounting base) 2 – 10° (without mounting base)
Protection degree	IP54
Temperature range	-22 – 140 °F if powered 14 – 140 °F without power
Humidity	0 – 95% non-condensing
Vibrations	< 2 G
Compliance	IEC 60335-2-103 ISO 13849-1 (PL "d"); IEC 61508 (SIL2)

*Specifications are subject to changes without prior notice.
All values measured in specific conditions.*

LED SIGNAL



1. Laser head initialization
2. Output relay 2 activated (safety)



1. Output relay 1 activated (opening)



1. Calculation in progress
2. Exit the zone and wait



1. Define detection zone



1. Errors

INSTALLATION TIPS

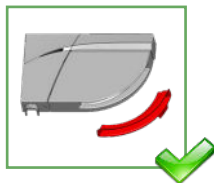

Remove the laser window protection before teach-in and commissioning.

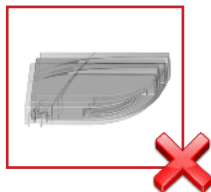

Avoid vibrations.

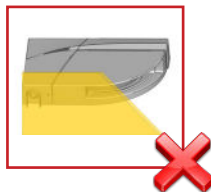

Do not cover the laser window.

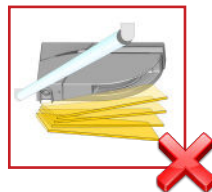

Avoid moving objects and light sources in the detection field.



Avoid the presence of smoke or fog in the detection field.



Avoid condensation.

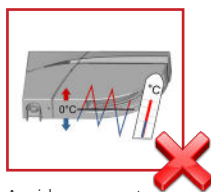

Avoid exposure to sudden and extreme temperature changes.

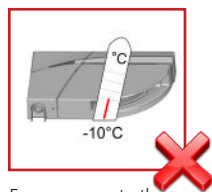

Ensure power to the sensor in areas where the temperature can reach below -10 °C.

MAINTENANCE TIPS



When needed, wipe the laser window only with a soft, clean and damp microfiber cloth.



Do not use dry or dirty towels or aggressive products to clean the laser window.



Avoid direct exposure to high-pressure cleaning.

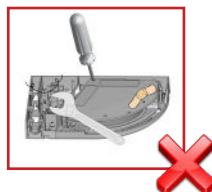

The warranty is invalid if unauthorized repairs are made or attempted by unauthorized personnel.

SAFETY TIPS

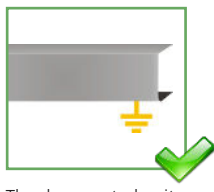

The door control unit and the header cover profile must be correctly grounded.

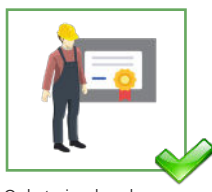

Only trained and qualified personnel are recommended to install and set up the sensor.



Always test for proper operation before leaving the premises.



Do not remove the laser window protection if building works are still in progress on site.

HOW TO USE THE REMOTE CONTROL



After unlocking, the red LED flashes and the sensor can be adjusted by remote control.



If the red LED flashes quickly after unlocking, you need to enter an access code from 1 to 4 digits. If you do not know the access code, **cycle the power**. During 1 minute, you can access the sensor without introducing any access code.



To end an adjustment session, always lock the sensor.



It is recommended to use a different access code for each sensor in order to avoid changing settings on both sensors at the same time.

SAVING AN ACCESS CODE

The access code is recommended for sensors installed close to each other.



DELETING AN ACCESS CODE



Enter the existing code

ADJUSTING ONE OR MORE PARAMETERS



CHECKING A VALUE



x = number of flashes = value of the parameter

2x 1x 3x 1x 5x = field width: 2.35 m

RESTORING TO FACTORY VALUES



! OPENING AND CLOSING THE SENSOR

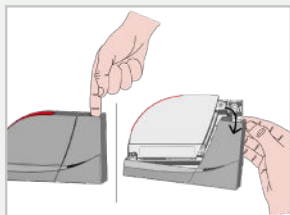

To open, insert your finger in the hole and then pull towards you in one movement.

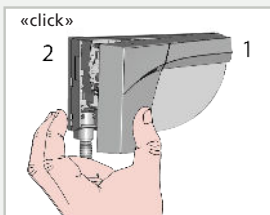

Close the cover starting on the narrow side (1). Do not hesitate to push (2).

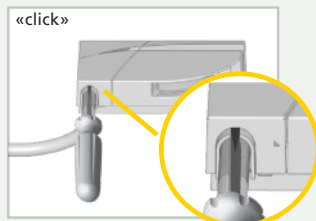

To open the sensor after it has been mounted, position a screwdriver in the notch and pull upwards until the cover comes loose.



When closing, be sure to secure the cover to avoid vibrations.

1 MOUNTING

SURFACE MOUNTING

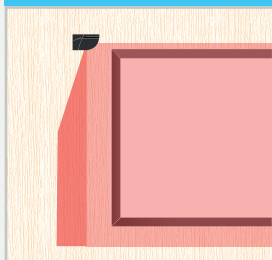

NICHE MOUNTING

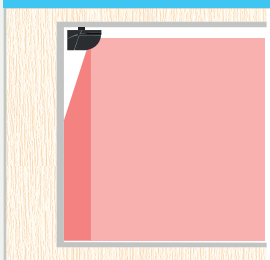

NICHE MOUNTING

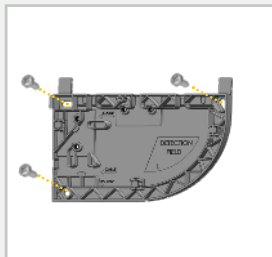
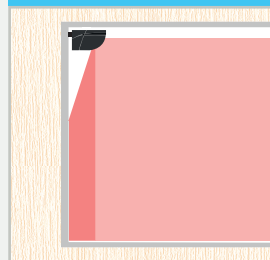

TOP MOUNT

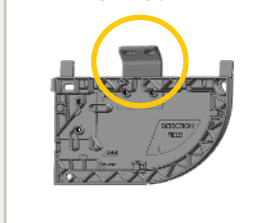

SIDE MOUNT

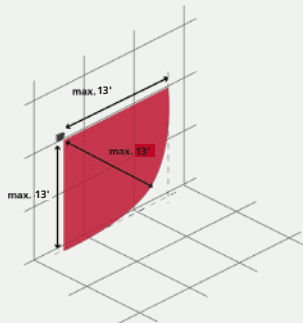
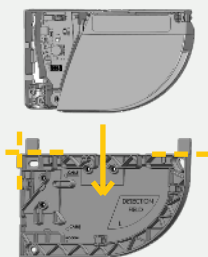
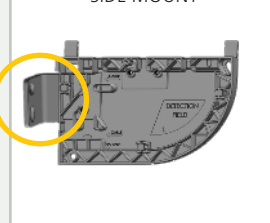

2 WIRING

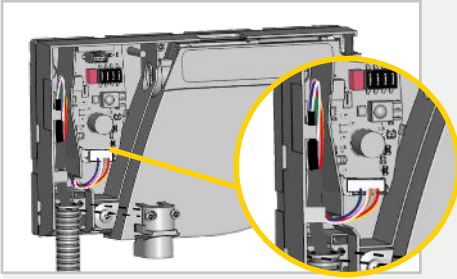

Create a loop with the wires of the power cable and pass them through the notch as indicated.

Block the cable behind the notches. You can use the flexible cable to guide the cable.

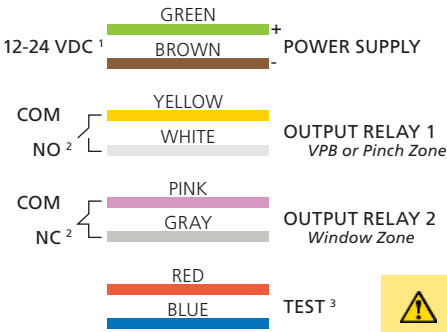

Cut the power cable to the right length, strip the 8 wires and connect all wires as indicated.

The polarity of the power supply must be respected!



Typical compliance with safety standards require the test output to be connected and monitored via controller.

1. If only VAC power is available, a 12V transformer paired with a rectifier must be used. Do not use a 24V transformer and rectifier as this will cause damage to the product.
2. Output status when sensor is operational (can be NO or NC). See page 10, OUTPUT CONFIGURATION.
3. If TEST is not used, apply 12 – 24 VDC to TEST wires (red and blue) to bypass.

3 ADJUSTING CURTAIN ANGLE

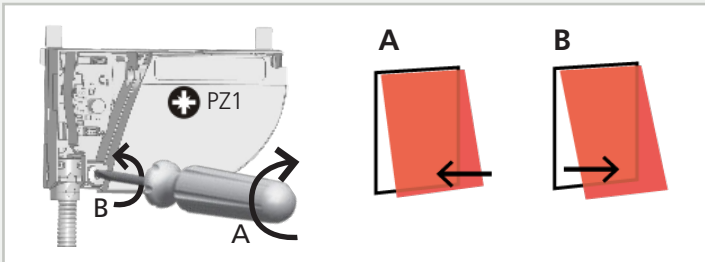

If necessary, adjust the tilt angle of the laser curtain by turning the tilt angle adjustment screw.

4 DIP SWITCH SETTINGS



DIP 1	BACKGROUND ANALYSIS	ON	OFF	ON: The sensor analyses the background located in the detection field. OFF: The sensor works with an uncovered zone of min. 2 cm.
DIP 2	IMMUNITY	standard	critical	Switch to CRITICAL when external disturbances are likely to cause unwanted detections (increased immunity).
DIP 3	OBJECT SIZE	$\frac{3}{4}$ "	$2 \frac{1}{3}$ "	See MIN. OBJECT SIZE setting
DIP 4	PINCH ZONE	ON	OFF	See OPTIONAL PINCH ZONE DIMENSIONS setting



After changing a DIP switch, the orange LED flashes.
A LONG push on the push button confirms the settings.

5 TEACH-IN



Before launching a teach-in, make sure that:

- the detection field is free of objects
- the laser window protection cap is removed
- glass surfaces near the detection zone are covered

1. To launch a teach-in, press the push button briefly or use the remote control (see below).
2. The LED will flash red/green. Wait until it slowly flashes green.
3. Position yourself in front of the detection field and stretch out your arm in the bottom corner opposite to the sensor in order to define the limit of the detection zone.
4. The LED flashes red while calculating the detection zone. Once the LED is off, the teach-in is complete.

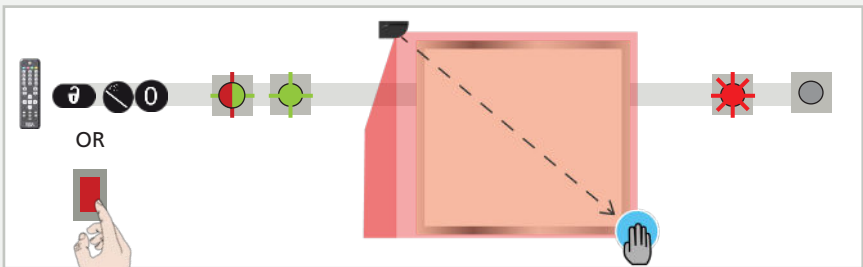

5 TEACH-IN

FREE SHAPE TEACH-IN

You can also set the detection field by launching a "free shape" teach-in.

The shape and limit of the detection field is defined by a slow hand movement.

You have 30 seconds to define the detection field with your hand.

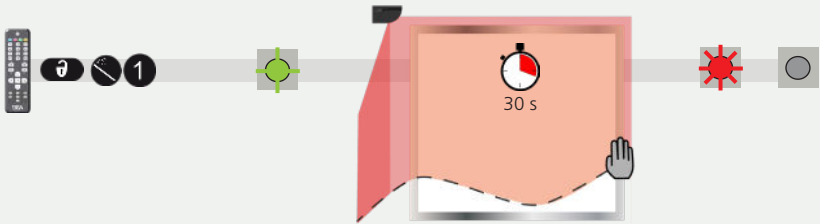

VIRTUAL PUSH BUTTONS (VPB)

After either one of the previous teach-ins, you can add virtual push buttons (max. 10) in the detection field. They can be used as activation zones to open or close the window automatically:

1. When the green LED flashes, hold your hand in the desired position to learn the virtual push button.
2. When the LED flashes red to confirm the teach-in, remove your hand.
3. When the LED flashes green you can either learn another virtual push button or wait 10 seconds until the end of the teach-in.

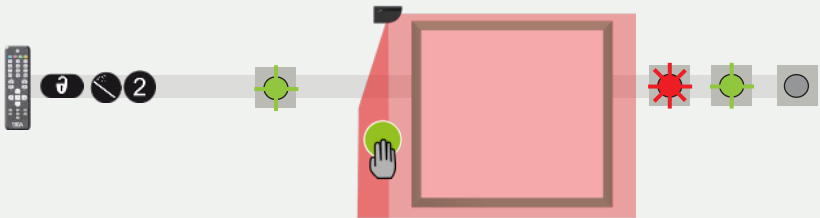

HOW TO REMOVE VPBs:

- Perform a VPB teach-in without putting your hand in the field.
- Perform a factory reset on the sensor.

Both of these options will remove ALL established virtual push buttons. You will have to perform new teach-ins for any that you wish to remain for your application.



Launch a new teach-in each time the sensor position is changed or objects are added to or changed in the detection zone.

REMOTE CONTROL SETTINGS (OPTIONAL)

DIMENSIONS DETECTION ZONE

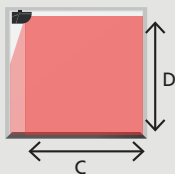

C* ↔ 0 0 0 0 0 1 - 4 0 0
no field 001 400 cm

D* ↔ 0 0 0 0 0 1 - 4 0 0
no field 001 400 cm

* A teach-in overwrites these values automatically. Resolution: 1 cm

OPTIONAL PINCH ZONE DIMENSIONS

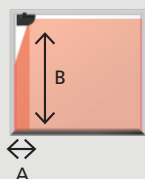

A ↔ 0 0 0 0 0 1 - 1 0 0
no field 001 040 cm

B* ↔ 0 0 0 0 0 1 - 4 0 0
no field 001 400 cm

* A teach-in overwrites these values automatically. Resolution: 1 cm

IMMUNITY FILTER

Increase to filter out external disturbances.

DIP 2 must be set to ON to change these settings by remote control.

👤 1 2 3 4 5 6 7 8 9
low > > > > > > > high

MIN. OBJECT SIZE (indicative values)

DIP 3 must be set to ON to change these settings by remote control.

🚩 1 2 3 4 5 6 7 8 9
2 cm 4 cm 6 cm 8 cm 10 cm 12 cm 14 cm 16 cm 18 cm

measured in specific conditions and dependant on application and installation

UNCOVERED ZONE WHEN BACKGROUND ANALYSIS IS OFF

F2 1 2 3 4 5 6 7 8 9
2 cm 4 cm 6 cm 8 cm 10 cm 12 cm 14 cm 16 cm 18 cm

measured in specific conditions and dependant on application and installation

 FACTORY VALUES

REMOTE CONTROL SETTINGS (OPTIONAL)

OUTPUT CONFIGURATION

	1	2	3	4	
R1	NO	NC	NC	NO	NO = normally open NC = normally closed
R2	NC	NO	NC	NO	

	NO	NC
NO POWER		
NO DETECTION		
DETECTION		

REDIRECTION OF PINCH ZONE

F1	1	2	3	
R1	R2	R1+R2		Note: Green LED for setting #1 only.

GENERAL

0	1	2	8	9
teach-in	teach-in free shape	teach-in virtual push buttons	full reset	partial reset
see page 6	see page 6	see page 6	factory reset of all values	factory reset of all values except field dimensions & output configurations

SERVICE MODE

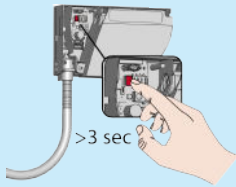

Service mode deactivates the safety detection for 15 minutes and can be useful during an installation, a mechanical teach-in of the window, or maintenance work.

To enter service mode, press the red button for at least 3 seconds. The LED will be OFF when the sensor is in service mode.

To exit service mode, press again for at least 3 seconds.

Service mode will automatically deactivate when a teach-in is launched.

TROUBLESHOOTING



In case of unwanted reactions of the window, verify whether the problem is caused by the sensor or the control.

To do so, activate service mode (no safety) and cycle the window. If the window opens and/or closes, check the sensor. If not, verify the control or the wiring.

	<p>The RED or GREEN LED is ON sporadically or permanently and the system does not react as expected.</p>	<p>Unwanted detections (due to environment or external conditions)</p>	<p>Make sure the flexible cable does not cause detections.</p> <p>Has there been changes in the environment? New objects?</p> <p>Verify if the laser window is dirty and clean it carefully with a damp and clean microfibre cloth if necessary (attention: the surface of the laser window is delicate)</p> <p>Launch a new teach-in.</p> <p>Switch DIP 2 to off (critical environment).</p>
	<p>The sensor does not react at power-on.</p>	<p>Inverted power supply</p> <p>Faulty cable</p> <p>Faulty sensor</p>	<p>Check wiring (green +, brown -).</p> <p>Replace cable.</p> <p>Replace sensor.</p>
	<p>The sensor does not react when powered.</p>	<p>Test error</p> <p>The service mode is activated.</p> <p>Standby mode is activated.</p>	<p>Check wiring between red and blue wires.</p> <p>Press the push button during at least 3 seconds to exit the service mode.</p> <p>Check wiring between red and blue wires.</p>
	<p>It is not possible to adjust a setting by remote control.</p>	<p>Wrong DIP switch position.</p> <p>Sensor is password-protected</p>	<p>Adjust the required DIP switches to ON.</p> <p>Enter the access code. If you have forgotten the access code, cut and restore the power supply to access the sensor without an access code within 1 minute.</p>
	<p>The ORANGE LED is on permanently.</p>	<p>The sensor encounters a memory problem.</p>	<p>Replace sensor.</p>
	<p>The ORANGE LED flashes quickly.</p>	<p>DIP switch setting awaiting confirmation.</p>	<p>Confirm the DIP switch setting: long push on the push button.</p>
	<p>The ORANGE LED flashes 1 x every 3 seconds.</p>	<p>The sensor signals an internal fault.</p>	<p>Cut and restore power supply. If orange LED flashes again, replace sensor.</p>
	<p>The ORANGE LED flashes 2 x every 3 seconds.</p>	<p>Power supply is out of limit.</p> <p>Internal temperature is too high.</p>	<p>Check power supply (voltage).</p> <p>Reduce the cable length or change cable.</p> <p>Protect the sensor from any heat source (sun, hot air, etc).</p>
	<p>The ORANGE LED flashes 3 x every 3 seconds.</p>	<p>Communication error</p>	<p>Check internal wiring between interface card and laser head.</p>
	<p>The ORANGE LED flashes 4 x every 3 seconds.</p>	<p>Something close to the sensor is masking part of the detection field.</p>	<p>Make sure the laser window is not scratched. If it is, replace sensor.</p> <p>Remove all masking elements (insects, spider web, window protection).</p> <p>Verify if the laser window is dirty and clean it carefully with a damp and clean microfibre cloth if necessary (attention: the surface of the laser window is delicate)</p>
	<p>The ORANGE LED flashes 5 x every 3 seconds.</p>	<p>Teach-in error</p>	<p>Check whether all teach-in requirements are fulfilled (see page 8) and launch a new teach-in.</p> <p>Adjust the tilt angle of the laser curtain and launch a new teach-in.</p>

FOR ALL APPLICATIONS:

BEA, INC. INSTALLATION/SERVICE COMPLIANCE EXPECTATIONS

The installation is provided by CUSTOMER or its affiliates. BEA is not affiliated with CUSTOMER or any of its affiliates. BEA has no liability to CUSTOMER or the end user for any and all liability, claims, demands, obligations, actions, losses, costs, damages, fees or expenses (including attorneys' fees and legal costs) arising out of or in connection with product installation, or the end user's use of or inability to use the product, the installation services, product defects or malfunctions, including, but not limited to, any actual or alleged injury, damage, death or other consequence occurring to any person or property as a result, directly or indirectly, of installation, possession, or use of any product or services provided by CUSTOMER or any individual or entity acting for or on behalf of CUSTOMER, whether claimed by reason of breach of warranty, negligence, product defect or otherwise, and regardless of the form in which any such claim is made (collectively, the "Released Matters"). You, on behalf of yourself and each of the Releasor Parties, hereby releases and absolutely and irrevocably discharges each Hippo Party and their respective officers, directors, employees, representatives and agents from and against any Released Matters. You acknowledge and agree that the foregoing is a full and final release of all Released Matters, including those that are unknown, unanticipated or unsuspected or that may hereafter arise as a result of the discovery of new and/or additional facts, and you expressly waive all rights under Section 1542 of the Civil Code of California as well as any similar statutes of any other jurisdictions, which you acknowledge you have read and understood and which provides as follows: A GENERAL RELEASE DOES NOT EXTEND TO CLAIMS WHICH THE CREDITOR DOES NOT KNOW OR SUSPECT TO EXIST IN HIS FAVOR AT THE TIME OF EXECUTING THE RELEASE, WHICH IF KNOWN BY HIM MUST HAVE MATERIALLY AFFECTED HIS SETTLEMENT WITH THE DEBTOR.

FOR DOOR, WINDOW, OR GATE APPLICATIONS:

BEA, INC. INSTALLATION/SERVICE COMPLIANCE EXPECTATIONS

BEA, Inc., the sensor manufacturer, cannot be held responsible for incorrect installations or incorrect adjustments of the sensor/device; therefore, BEA, Inc. does not guarantee any use of the sensor/device outside of its intended purpose.

BEA, Inc. strongly recommends that installation and service technicians be AAADM-certified for pedestrian doors, IDA-certified for doors/gates, and factory-trained for the type of door/gate system.

Installers and service personnel are responsible for executing a risk assessment following each installation/service performed, ensuring that the sensor/device system performance is compliant with local, national, and international regulations, codes, and standards.

Once installation or service work is complete, a safety inspection of the door/gate shall be performed per the door/gate manufacturer's recommendations and/or per AAADM/ANSI/DASMA guidelines (where applicable) for best industry practices. Safety inspections must be performed during each service call – examples of these safety inspections can be found on an AAADM safety information label (e.g. ANSI/DASMA 102, ANSI/DASMA 107, UL294, UL325, and International Building Code).

Verify that all appropriate industry signage, warning labels, and placards are in place.



A Halma company

Tech Support & Customer Service: 1-800-523-2462

General Tech Questions: techservices-us@BEAsensors.com | Tech Docs: www.BEAsensors.com