

SECTION A-A

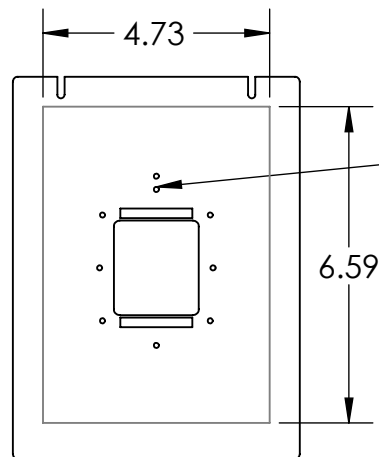
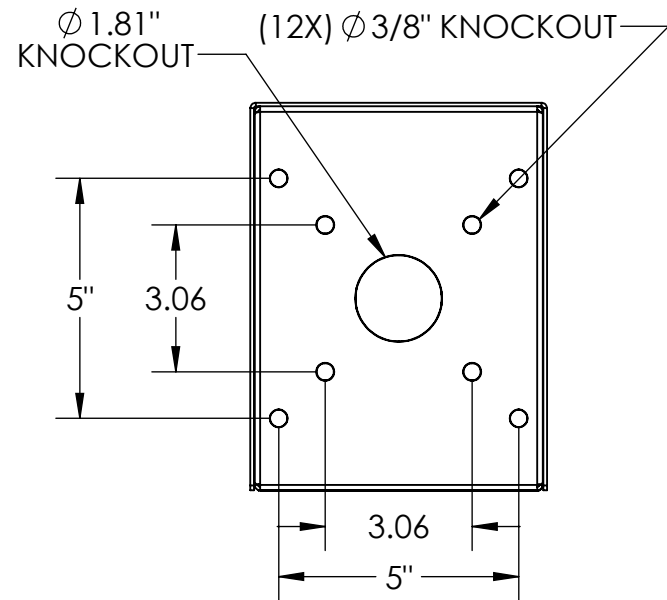

AVAILABLE CUTOUT AREA

PAXTON 521-715-US, 521-836-US

NOTES:

1. MATERIAL OF CONSTRUCTION IS MILD STEEL.
2. 2-4 MILS BLACK WRINKLE POWDER COAT.

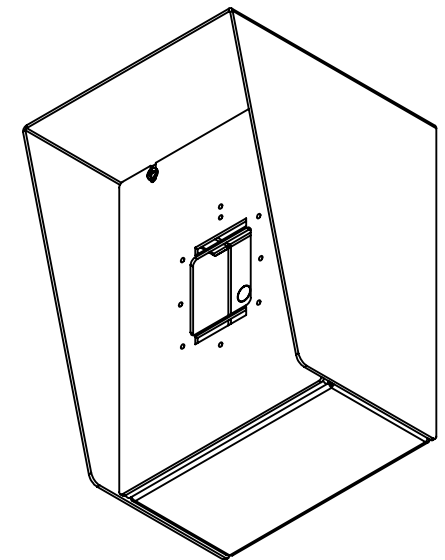

PEDESTALPRO.COM
1-800-660-3072

UNLESS OTHERWISE SPECIFIED:

DIMENSIONS ARE IN INCHES
TOLERANCES:
FRACTIONAL: $\pm 1/32$
ANGULAR: $\pm 2^\circ$
TWO PLACE DECIMAL: ± 0.010
THREE PLACE DECIMAL: ± 0.005

INTERPRET GEOMETRIC
TOLERANCING PER:
ASME Y14.5 -2009

NAME	DATE
DRAWN	
CHECKED	

PROPRIETARY AND CONFIDENTIAL
THE INFORMATION CONTAINED IN THIS DRAWING IS THE SOLE PROPERTY OF PEDESTALPRO LLC. ANY REPRODUCTION IN PART OR AS A WHOLE WITHOUT THE WRITTEN PERMISSION OF PEDESTALPRO LLC IS PROHIBITED.

TITLE:
INSTALLATION

Friday, May 26, 2023
2:41:20 PM

WEIGHT: 6.487

SIZE	PART NO.	REV
A	68HOU-PAXT-02-CRS	C
NO SCALE		SHEET 1 OF 6

ITEM NO.	PART NUMBER	DESCRIPTION	QTY.
1	68HOU-PAXT-02-CRS ENCLOSURE	ENCLOSURE WELDMENT	1
2	68HOU-PAXT-02-CRS DOOR	DOOR WELDMENT	1
3	HINGE	PIANO HINGE	1
4	GASKET SIDE	3/8" X .150 WEATHERSTRIPPING	2
5	GASKET TOP	3/8" X .150 WEATHERSTRIPPING	1
6	--	6-32 PAN HEAD SCREW	4
7	--	6-32 EXTERNAL TOOTH LOCK NUT	2

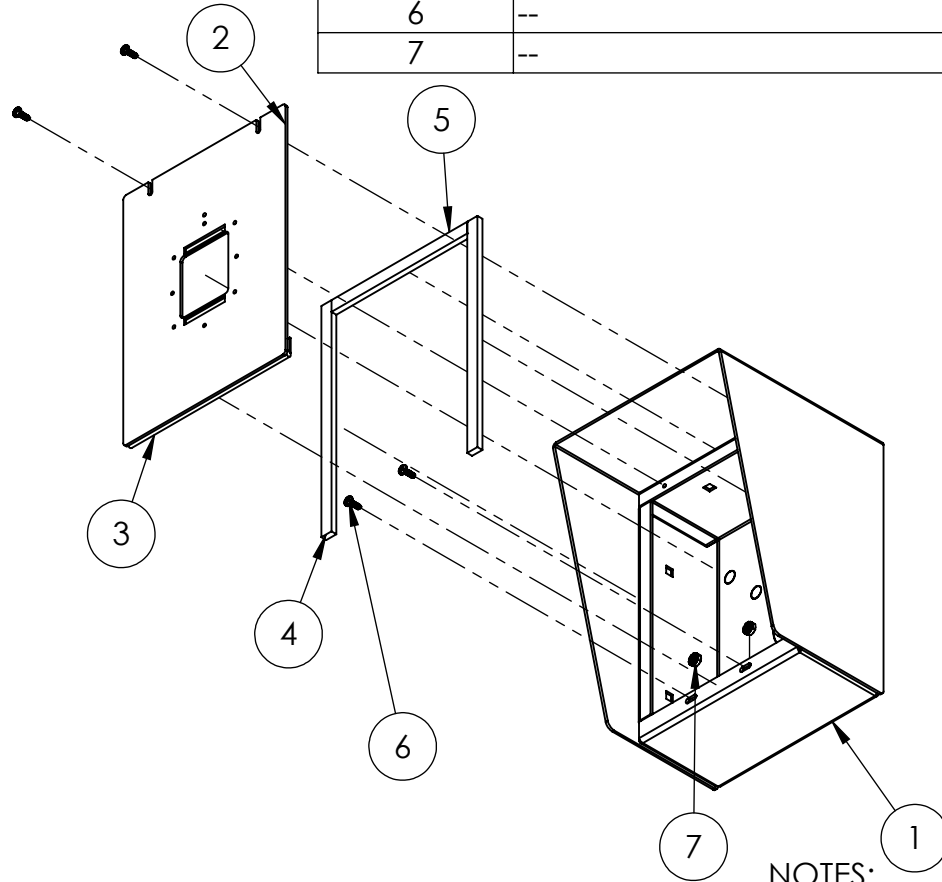

NOTES:

1. SEE STANDARD PREPARATION AND COATING INSTRUCTIONS FOR COATING PROCEDURE AND COLOR.
2. SEE STANDARD PACKAGING INSTRUCTIONS FOR PACKAGING PROCEDURE.



PEDESTALPRO.COM
1-800-660-3072

UNLESS OTHERWISE SPECIFIED:

DIMENSIONS ARE IN INCHES
TOLERANCES:
FRACTIONAL $\pm 1/32$
ANGULAR: $\pm 2^\circ$
TWO PLACE DECIMAL ± 0.010
THREE PLACE DECIMAL ± 0.005

INTERPRET GEOMETRIC
TOLERANCING PER:
ASME Y14.5 -2009

NAME DATE

DRAWN

CHECKED

PROPRIETARY AND CONFIDENTIAL

THE INFORMATION CONTAINED IN THIS
DRAWING IS THE SOLE PROPERTY OF
PEDESTALPRO LLC. ANY REPRODUCTION
IN PART OR AS A WHOLE WITHOUT THE
WRITTEN PERMISSION OF PEDESTALPRO LLC
IS PROHIBITED.

TITLE:

ASSEMBLY

Tuesday, September
11, 2018 9:34:19 AM

WEIGHT: 6.487

SIZE
A

PART NO.
68HOU-PAXT-02-CRS

REV
C

NO SCALE

SHEET 2 OF 6