

FITS PAXTON P75 SERIES READERS

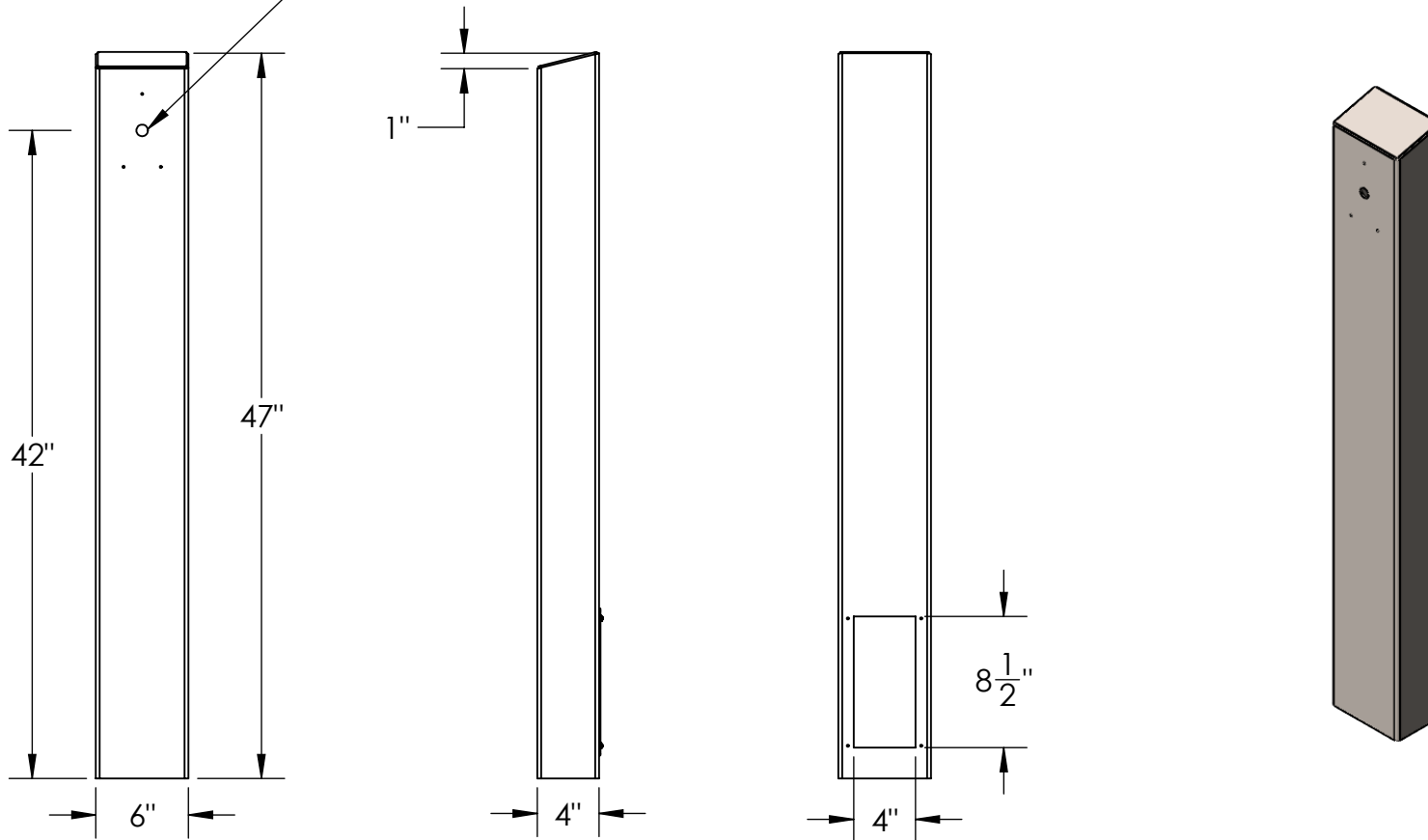

NOTES:

1. 1/2" ϕ MOUNTING HARDWARE IS RECOMMENDED FOR 5X5 BASEPLATE AND STAINLESS TOWER MODELS. L-BOLT-500, STUD-ANCHOR-500.
2. 5/8" ϕ MOUNTING HARDWARE IS RECOMMENDED FOR 8X8 BASEPLATE, 12X12 BASEPLATE, AND BOLLARD STYLE BASEPLATE MODELS. L-BOLT-625, STUD-ANCHOR-625.
3. MATERIAL OF CONSTRUCTION IS 304SS BRUSHED #4 FINISH.



PEDESTALPRO.COM
1-800-660-3072

UNLESS OTHERWISE SPECIFIED:

DIMENSIONS ARE IN INCHES
TOLERANCES:
FRACTIONAL $\pm 1/32$
ANGULAR: $\pm 2^\circ$
TWO PLACE DECIMAL ± 0.010
THREE PLACE DECIMAL ± 0.005

INTERPRET GEOMETRIC
TOLERANCING PER:
ASME Y14.5 -2009

NAME	DATE
DRAWN	
CHECKED	

PROPRIETARY AND CONFIDENTIAL

THE INFORMATION CONTAINED IN THIS DRAWING IS THE SOLE PROPERTY OF PEDESTALPRO LLC. ANY REPRODUCTION IN PART OR AS A WHOLE WITHOUT THE WRITTEN PERMISSION OF PEDESTALPRO LLC IS PROHIBITED.

TITLE:
INSTALLATION

Tuesday, October 23,
2018 12:52:42 PM

WEIGHT:

SIZE	PART NO.	REV
A	64TOW-PAXT-08-304	B
NO SCALE		SHEET 1 OF 7

ITEM NO.	PART NUMBER	DESCRIPTION	QTY.
1	64TOW-PAXT-08-304 TUBE	TOWER WELDMENT	1
2	PLTACC-510	STND 5.25 X 8.5 ACCESS COVER	1
3	--	8-32 SS BUTTON HEAD SCREW	4

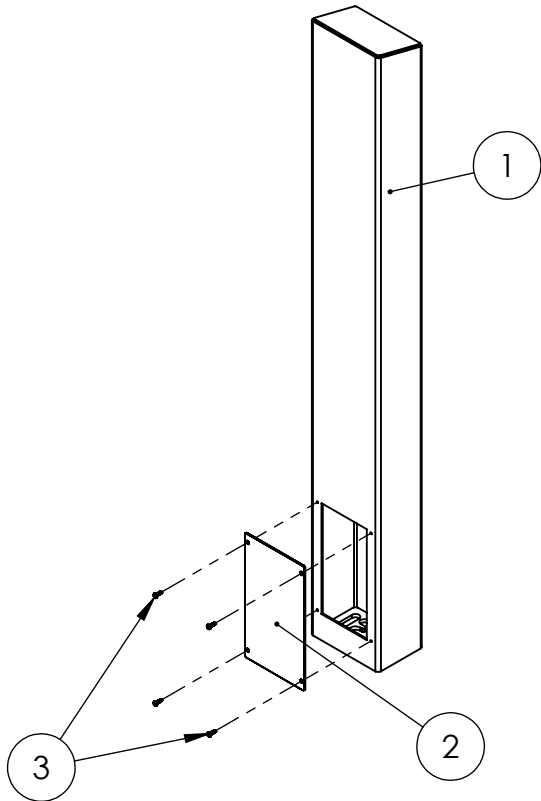

NOTES:

1. SEE STANDARD PREPARATION AND COATING INSTRUCTIONS FOR COATING PROCEDURE AND COLOR
2. SEE STANDARD PACKAGING INSTRUCTIONS FOR PACKAGING PROCEDURE



PEDESTALPRO.COM
1-800-660-3072

UNLESS OTHERWISE SPECIFIED:

DIMENSIONS ARE IN INCHES
TOLERANCES:
FRACTIONAL $\pm 1/32$
ANGULAR: $\pm 2^\circ$
TWO PLACE DECIMAL ± 0.010
THREE PLACE DECIMAL ± 0.005

INTERPRET GEOMETRIC TOLERANCING PER: ASME Y14.5 -2009

NAME	DATE
DRAWN	
CHECKED	
PROPRIETARY AND CONFIDENTIAL	
THE INFORMATION CONTAINED IN THIS DRAWING IS THE SOLE PROPERTY OF PEDESTALPRO LLC. ANY REPRODUCTION IN PART OR AS A WHOLE WITHOUT THE WRITTEN PERMISSION OF PEDESTALPRO LLC IS PROHIBITED.	

TITLE: ASSEMBLY		DATE: Tuesday, October 23, 2018 12:52:42 PM	SIZE: A	PART NO. 64TOW-PAXT-08-304	REV B
WEIGHT:		NO SCALE	SHEET 2 OF 7		