

5MP HD IR Fixed Eyeball Network Camera

IPC3615SR3-ADF28(40)KM-G



Key Features



- High quality image with 5MP, 1/2.7"CMOS sensor
- 5MP (2880*1620)@ 25/20fps; 4MP (2560*1440)@ 25/20fps; 3MP (2304*1296) @30/25fps; 2MP (1920*1080) @30/25fps;
- Ultra 265, H.265, H.264, MJPEG
- LightHunter technology ensures high image quality in low illumination environment
- 120dB true WDR technology enables clear image in strong light scene
- Support 9:16 Corridor Mode
- Built-in Mic
- Smart IR, up to 30m (98ft) IR distance
- Supports 256 G Micro SD card
- IP67 protection
- Support PoE power supply
- 3-Axis

Specifications

	IPC3615SR3-ADF28KM-G	IPC3615SR3-ADF40KM-G			
Camera					
Sensor	1/2.7", 5.0 megapixel, progressive scan, CMOS				
Lens	2.8mm@F1.6		4.0mm@F1.6		
DORI Distance	Lens (mm)	Detect (m)	Observe (m)	Recognize (m)	Identify (m)
	2.8	63.0	25.2	12.6	6.3
	4.0	90.0	36.0	18.0	9.0
Angle Of View (H)	112.9°		91.2°		
Angle Of View (V)	59.1°		47.9°		
Angle Of View (O)	121.2°		95.9°		
Adjustment angle	Pan: 0° ~ 360°		Tilt: 0° ~ 80°		Rotate: 0° ~ 360°
Shutter	Auto/Manual, 1 ~ 1/100000s				
Minimum Illumination	Support LightHunter: Colour: 0.003Lux (F1.6, AGC ON) 0Lux with IR				
Day/Night	IR-cut filter with auto switch (ICR)				
Digital noise reduction	2D/3D DNR				
S/N	>56dB				
IR Range	Up to 30m (98ft) IR range				
Wavelength	850nm				
IR On/Off Control	Auto/Manual				
Defog	Digital Defog				
WDR	120dB				
Video					
Video Compression	Ultra 265, H.265, H.264, MJPEG				
H.264 Code Profile	Baseline profile, Main profile, High profile				
Frame Rate	Main Stream: 5MP (2880*1620), Max 25fps;4MP (2560*1440), Max 25fps; 3MP (2304*1296), Max 30fps; 1080P (1920*1080), Max 30fps; Sub Stream: 720P (1280*720), Max 30fps; D1 (720*576), Max 30fps; 640*360,Max 30fps; 2CIF(704*288), Max 30fps; CIF(352*288), Max 30fps;				
Video Bit Rate	128 Kbps~16 Mbps				
9:16 Corridor Mode	Supported				
OSD	Up to 4 OSDs				
Privacy Mask	Up to 4 areas				
ROI	Up to 8 areas				
Motion Detection	Up to 4 areas				
Image					
White Balance	Auto/Outdoor/Fine Tune/Sodium Lamp/Locked/Auto2				
Digital noise reduction	2D/3D DNR				
Smart IR	Supported				
Flip	Normal/Vertical/Horizontal/180°/90°Clockwise/90°Anti-clockwise				
Dewarping	N/A				

HLC	Supported
BLC	Supported
Smart	
Behavior Detection	(Cross line, intrusion)based on human body detection, motion detection, tampering alarm, audio detection
General Function	Watermark, IP address filtering, access policy, ARP protection, RTSP authentication, user authentication, HTTP authentication
Network	
Protocols	IPv4, IGMP, ICMP, ARP, TCP, UDP, DHCP, RTP, RTSP, RTCP, RTMP, DNS, DDNS, NTP, FTP, UPnP, HTTP, HTTPS, SMTP, SSL, 802.1x, SNMP
Compatible Integration	ONVIF (Profile S, Profile G, Profile T), API
Client	EZStation EZView EZLive
Web Browser	Plug-in required live view: IE9+, Chrome 41 and below, Firefox 52 and below
	Plug-in free live view: Chorme 57.0+, Firefox 58.0+, Edge 16+
Audio	
Audio Compression	G.711
Suppression	Supported
Sampling Rate	8KHZ
Storage	
Edge Storage	Micro SD, up to 256 GB
Network Storage	ANR,NAS(NFS)
Interface	
Network	10/100M Base-TX Ethernet
Built-in Mic	Supported
Certifications	
Certifications	UL: UL60950-1 FCC: FCC Part 15
General	
Power	DC 12V±25%, PoE (IEEE 802.3af)
	Power consumption: Max 6.0W
Dimensions (∅ x H)	∅110.5 x 94.1mm (∅4.4" x 3.7")
Net Weight	0.43kg (0.95lb)
Material	Metal
Working Environment	-30°C ~ 60°C (-22°F ~ 140°F), Humidity: ≤95% RH (non-condensing)
Storage Environment	-30°C ~ 60°C (-22°F ~ 140°F), Humidity: ≤95% RH (non-condensing)
Surge Protection	4KV
Ingress Protection	IP67
Reset Button	N/A

Dimensions

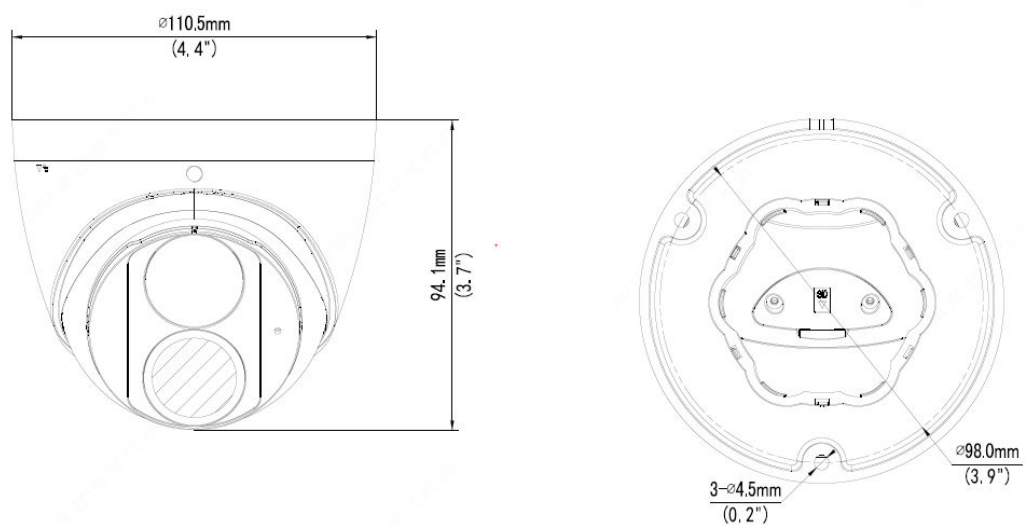

Accessories

TR-JB03-G-IN



TR-JB07/WM03-G-IN



TR-WM03-D-IN

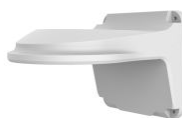

TR-UM06-E-IN



TR-UP06-IN



TR-A01-IN



TR-SE24-IN



TR-SE24-A-IN



TR-CM24-IN

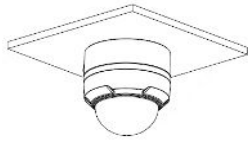
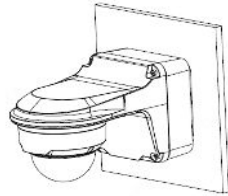
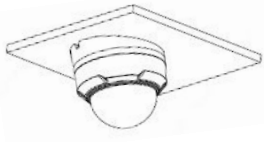
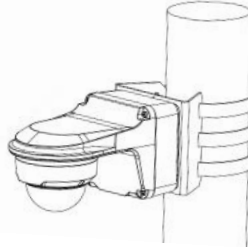
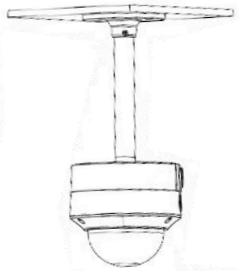

Junction Mount	Pole Mount
TR-JB03-G-IN 	TR-JB07/WM03-G-IN 
TR-UM06-E-IN 	TR-JB07/WM03-G-IN+TR-UP06-IN 
TR-CM24-IN+TR-JB03-G-IN 	

Zhejiang Uniview Technologies Co., Ltd.

Building No.10, Wanlun Science Park, Jiangling Road 88, Binjiang District, Hangzhou, Zhejiang, China (310051)

 Email: overseasbusiness@uniview.com; globalsupport@uniview.com
<http://www.uniview.com>

©2021 Zhejiang Uniview Technologies Co., Ltd. All rights reserved.

*Product specifications and availability are subject to change without notice.