

# TR-UF45-A-IN PTZ Dome Indoor Pendant Mount



## Specifications

Bracket	TR-UF45-A-IN
Application	Indoor, PTZ dome pendant installation
Dimensions	Φ116mmx30.5mm(Φ4.6" x1.2")
Weight	0.3kg(0.66lb)
Material	Aluminum alloy

## Dimensions

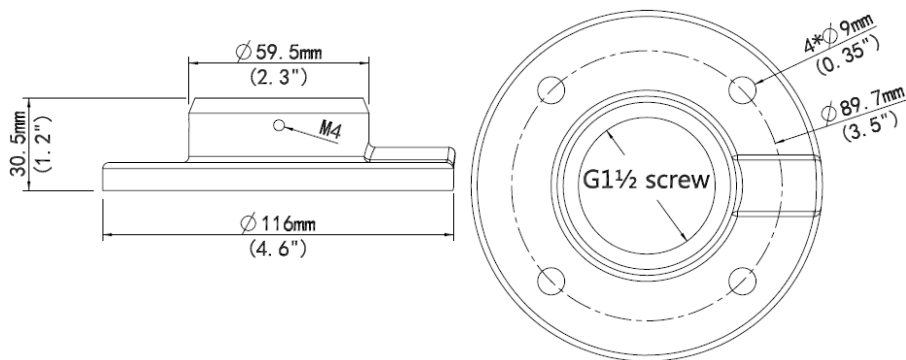

### Zhejiang Uniview Technologies Co.,Ltd.

South Tower, Building 10, Wanlun Science Park, 88 Jiangling Road, Hangzhou, P.R.China 310051

Email: [overseasbusiness@uniview.com](mailto:overseasbusiness@uniview.com); [globalsupport@uniview.com](mailto:globalsupport@uniview.com)

<http://www.uniview.com>

©2015 Zhejiang Uniview Technologies Co.,Ltd. All rights reserved.

\*Product specifications and availability are subject to change without notice.